

YOUR **OFFICIAL** RASPBERRY PI MAGAZINE

The *MagPi*

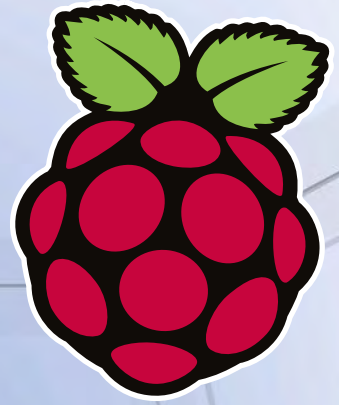

The official Raspberry Pi magazine

Issue 47 July 2016

raspberrypi.org/magpi

BLUETOOTH TAGGING

Automate just about anything with a Pi 3

AMAZING OPTICAL ILLUSIONS

Master persistence of vision with Pi Zero

LEARN TO CODE IN C

Our latest expert series starts this issue

TERRAFORM MINECRAFT

Another amazing Minecraft Pi hack

MISSION ACCOMPLISHED

Celebrating Tim Peake & Raspberry Pi's amazing space mission



Also inside:

- > SKYCADEMY: TAKE YOUR PI TO THE EDGE OF SPACE
- > START BUILDING A PI-POWERED ARCADE MACHINE
- > THE ULTIMATE RASPBERRY PI KARAOKE PROJECT
- > THE MOTOZERO ROBOT BOARD REVIEWED

PET PROJECTS!

10 fantastic Pi-powered makes for your furry friends

 Issue 47 • Jul 2016 • £5.99



9 772051 998001

THE **ONLY** PI MAGAZINE WRITTEN BY THE RASPBERRY PI COMMUNITY

VNC SDK *now available for*

RASPBERRY PI!

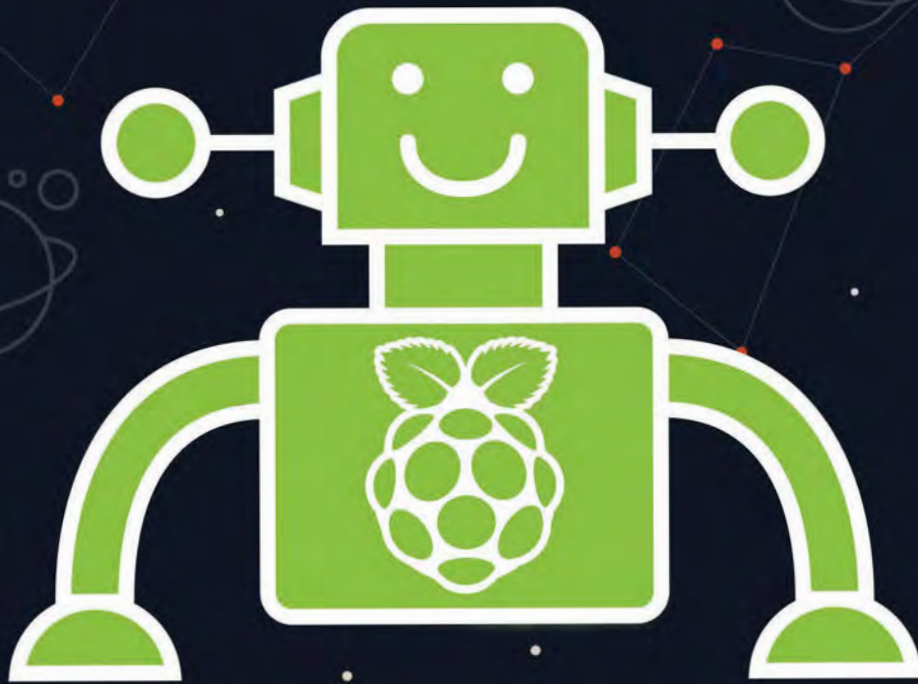

With VNC SDK you can connect VNC Viewers with VNC Servers easily over the Internet. Using VNC Cloud, no complicated network configuration at either end is required!

What will you create with VNC SDK?
Check it out here: <https://developer.realvnc.com/>

REAL
VNC

VNC DEVELOPER

Getting connected: www.realvnc.com/products/vnc/raspberrypi/
For more information contact vncdeveloper@realvnc.com

WELCOME TO THE OFFICIAL PI MAGAZINE!

In December last year, British Army Air Corps officer Timothy Nigel Peake stepped aboard the Soyuz TMA-19M to start a six-month mission aboard the International Space Station. It was a small step across the ISS hatch for Tim, but as the first British European Space Agency astronaut it was a giant leap for the United Kingdom and especially the children that dream of one day going to space.

Tim wasn't the only UK-born passenger aboard the ISS, though; two Raspberry Pis joined him on his mission to carry out experiments developed by British schoolchildren. While Tim returned to Earth on 18 June, our two intrepid Raspberry Pis, Ed and Izzy, remain aboard to continue their ongoing mission to inspire and educate children all over the world via the Astro Pi programme. You can learn all about Astro Pi in our massive cover feature starting on page 14, and how Astro Pi and other educational programmes Tim has been involved with have touched the lives of and inspired more than a million schoolchildren.

Enjoy the issue!

Russell Barnes
Managing Editor



THIS MONTH:

- 14 ASTRO PI: MISSION ACCOMPLISHED**
We look at this amazing collaboration, but it's not over yet!
- 32 THE ULTIMATE RETRO PHONE**
Martin Mander is back with another stunning Pi project
- 46 TERRAFORM MINECRAFT**
Become the destroyer of worlds in Minecraft Pi
- 72 YOUR PET PROJECTS**
10 amazing community creations for your furry friends

FIND US ONLINE raspberrypi.org/magpi

GET IN TOUCH magpi@raspberrypi.org



EDITORIAL

Managing Editor: **Russell Barnes**
russell@raspberrypi.org
Features Editor: **Rob Zwetsloot**
Sub Editors: **Laura Clay, Phil King, Lorna Lynch**

DISTRIBUTION

Seymour Distribution Ltd
2 East Poultry Ave
London
EC1A 9PT | +44 (0)207 429 4000

DESIGN

Critical Media: criticalmedia.co.uk
Head of Design: **Dougal Matthews**
Designers: **Lee Allen, Mike Kay**
Cover photography: **Gareth Halfacree**

SUBSCRIPTIONS

Select Publisher Services Ltd
PO Box 6337
Bournemouth
BH1 9EH | +44 (0)1202 586 848

PUBLISHING

For advertising & licensing:
russell@raspberrypi.org +44 (0)7904 766523
Publisher: **Liz Upton**
CEO: **Eben Upton**

CONTRIBUTORS

Sam Aaron, Dan Aldred, Wesley Archer, Mike Cook, Lucy Hattersley, Richard Hayler, Phil King, Simon Long, Alan McCullagh, Matt Richardson & Richard Smedley, Lucy Rogers & Francesco Vannini

This magazine is printed on paper sourced from sustainable forests and the printer operates an environmental management system which has been assessed as conforming to ISO 14001.

The MagPi magazine is published by Raspberry Pi (Trading) Ltd., 30 Station Road, Cambridge, CB1 2JH. The publisher, editor and contributors accept no responsibility in respect of any omissions or errors relating to goods, products or services referred to or advertised in the magazine. Except where otherwise noted, content in this magazine is licensed under a Creative Commons Attribution-NonCommercial-ShareAlike 3.0 Unported (CC BY-NC-SA 3.0). ISSN: 2051-9982.



Contents

Issue 47 July 2016

raspberrypi.org/magpi

TUTORIALS

- > **PI 3 BLUETOOTH TAG 42**
Create automated events with a Pi and a smartphone
- > **WAKE DINO WITH NODE-RED 44**
Email a dinosaur to let people know dinner is ready
- > **MINECRAFT TERRAFORMING 46**
Program Minecraft to change its landscape
- > **EGG DROP GAME 48**
Make a Sense HAT game that uses the tilt sensor
- > **SONIC PI 50**
Create randomised drum patterns with Sonic Pi's creator
- > **PI BAKERY 52**
Build yet another amazing machine with Mike Cook
- > **ARCADE MACHINE BUILD (PT 1) 58**
Start building your own arcade cabinet from scratch
- > **PERSISTENCE OF VISION 60**
Create an optical illusion with a fast-spinning Pi Zero
- > **RASPBERRY BERET 64**
Put a camera on your head in this Pi-powered Prince tribute

IN THE NEWS

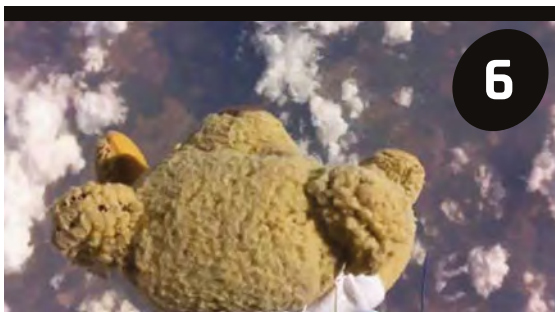

Pis in the sky

Everyone's talking about Raspberry Pi in the sky. Skycademy returns as records are broken with HABs



COVER FEATURE

ASTRO PI

Tim Peake has returned to Earth; let's see what he accomplished with Astro Pi



PI WARS 3

Pi Wars returns in 2017 to give people more time to make even cooler Pi-powered robots

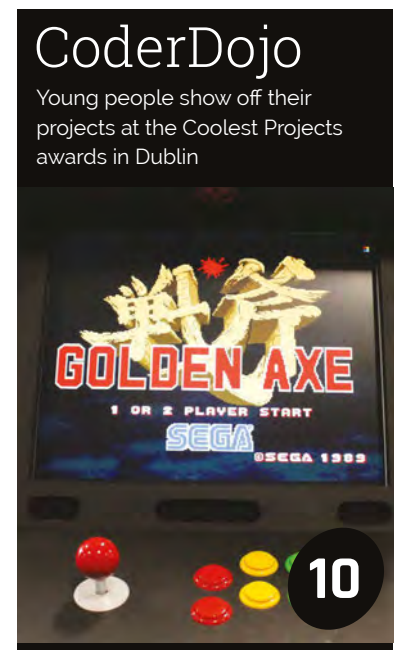

CoderDojo

Young people show off their projects at the Coolest Projects awards in Dublin

THE BIG FEATURE



72

THE BEST PI PET PROJECTS

Cute critters and the Raspberry Pis that people use to control them or make them famous on the internet

In association with IQaudIO

10 Pi-DAC+ with Pi-CASE+ smoked cases

MUST BE WON!

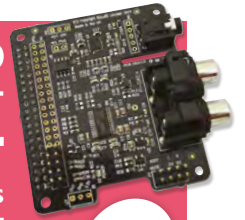

95

RASPBERRY PI SALES



An amazing 500,000 Raspberry Pis were sold in a single month

8

YOUR PROJECTS



32

ALEXAPHONE

This very Seventies telephone has been souped up with a Raspberry Pi

REGULARS

- > NEWS 06
The biggest stories from the world of Raspberry Pi
- > TECHNICAL FAQ 70
Got a problem? Maybe we can help...
- > BOOK REVIEWS 86
The best reads for coders and hackers
- > THE FINAL WORD 97
More musings from Raspberry Pi's Matt Richardson

COMMUNITY

- > THIS MONTH IN PI 88
We round up other goings-on in the Pi community
- > EVENTS 90
Get involved in a community gathering near you
- > YOUR LETTERS 92
Talk to us about the magazine or Raspberry Pi

REVIEWS

- > MOTOZERO 80
- > PI ZERO MOTOR SHIM 82
- > RASPIO HAT 83
- > CHICKBOT 84

Karaoke Box

34

A tiny karaoke box that lets you belt out your favourite pop song at full volume



Beekeeping Server

36

Raspberry Pis that bring you honey, although there are some bees involved



Bitcoin Clock

38

A clock that keeps track of Bitcoin stats and can store some money in it as well

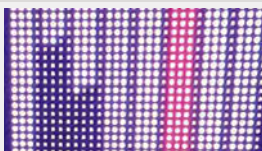



The balloon reached almost halfway to the edge of space, and only a few metres short of the 42km prediction

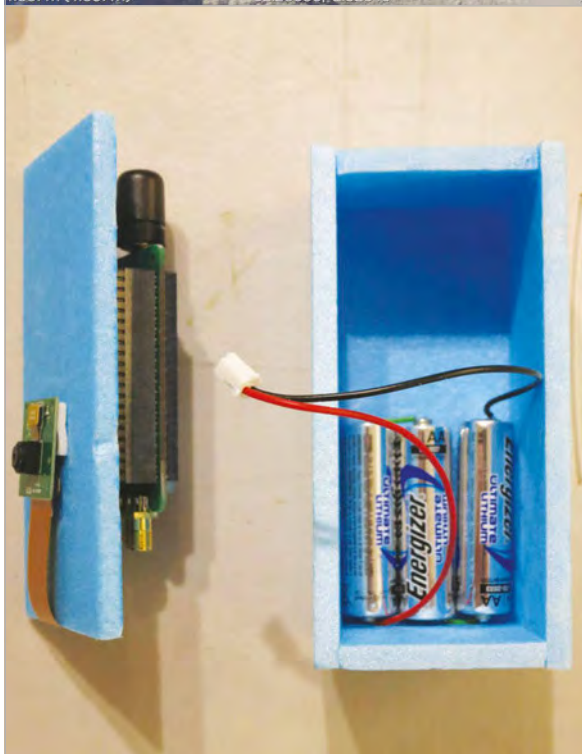

A basic case with the bare essentials needed to make things work, which is important when you're trying to save weight

HIGH-FLYING PI

Everyone has been talking about high-altitude ballooning this month; here's why...

If you've paid attention to high-altitude ballooning (HAB) within the Raspberry Pi community, you'll have no doubt heard of Dave Akerman. He's broken records thanks to Pis in HABs, specifically ones involving the highest altitude amateur live-transmitted pictures. It's very specialised, but still spectacular.

It probably comes as no surprise, then, to learn that he's broken the record once again, this time thanks to the recently released upgrade to the Raspberry Pi Zero. The new camera port is a big deal when you're doing something like this.

"I'd been pleading with Eben [Upton] since I first saw a prototype of the original Pi Zero. Its low weight would be ideal for live-imaging HAB applications, if only it had a camera port," Dave writes on the Raspberry Pi blog. "The camera is the entire reason for using a Pi for HAB; if

you don't want pictures, then a smaller/lighter/simpler AVR or PIC microcontroller will easily do the job, and with less battery power. I felt that the CSI-less Pi Zero was a missed opportunity. Eben agreed, and said he would try to make it happen."

New records

On launch day, Dave had to wait for the weather to clear before filling up the balloon, contending with some unexpected gusts of wind in the process. The predicted altitude for the payload before the balloon burst was 42km (26 miles), which is about double the altitude of the U-2 spy plane. Predictions weren't far off; the last photo sent from the camera before the balloon burst records an altitude of 41,837m. Dave believes this breaks any previous record he's made, and any others that have been made since.



SKYCADEMY 2016

Last year, Skycademy helped teachers around the UK to learn about performing HAB experiments in their schools. It was a huge success, so the Raspberry Pi Foundation is launching a new Skycademy course. The course will take place over three days, with the second day dedicated to launching and tracking a HAB. You can find out more information, and apply, online: magpi.cc/28J5Vma

A glimpse of Earth from space as Sam's SkiPi reaches high into the atmosphere

The Pi Camera Module went missing as the balloon burst, so if you have a very thorough search around Shropshire, you might just find the highest-flying Pi camera ever/so far.

A boy and his Pi

While Dave might be breaking more records, a 17-year-old student from Monmouth School, Sam Sully, was taking his first steps into Pi-powered ballooning with his own HAB project. After seeing Dave's original Pi in the Sky blog in 2012, Sam was eager to give it a go, but didn't have the skills to do so at the time.

"Now, four years later, I've gained many more skills," Sam tells us. "Last year I received an Arkwright Scholarship, giving me £300 to spend on anything to further my interests in engineering and computer science. I decided after a while that I could now do this project, and so I started my research."

His research brought him to the forums of the Raspberry Pi Foundation and to members of the UK High Altitude Society (UKHAS), where unsurprisingly he bumped into Dave as well

as other members. Completing his research, Sam built his SkiPi on the provided budget, using the skills in electronics and programming that he had developed for the task.

After two months of work, Sam took his payload and balloon to a field and filled it up with helium for its ascent over Monmouth. Dave even came down to spectate and give a hand if needed.

"I programmed the camera to take a picture every minute," Sam says. "These were stored on the Pi Zero. Then the Pi selected the best photos and transmitted them back to us. But my focus was on making sure I couldn't lose it."

The balloon reached a very respectable altitude of 32km in about an hour, before falling back down to Earth. It took some finding, but Sam managed to retrieve the payload and the rest of the photos.

"The pictures are beautiful," effuses Sam. "I've already shared them with people and set one as my desktop background. It's an amazing view from up there. People have reacted with amazement: they are really impressed that it actually worked."

DAVE'S FLIGHTS



Pi in the Sky

The reason we didn't name this news story 'Pi in the Sky'! Dave Akerman came to the community's attention when he originally broke that altitude record, using a Pi and a webcam, in July 2012.



Babbage's big jump

You may remember Felix Baumgartner, who managed to fall with so much style he broke the sound barrier. Dave tried to recreate this feat at a greater altitude, but with a Babbage bear as a passenger.



Heston Blumenthal's potato

As part of top chef Heston Blumenthal's *Great British Food* episode on pies, Dave launched a Heston-esque potato from a HAB. The potato survived its descent, but not Heston's plans to mash it up for dinner.

RASPBERRY PI 3 SELLS 500K IN FIRST MONTH

Biggest monthly sales of Raspberry Pi ever, following the Pi 3 launch

When the Raspberry Pi 3 was launched in February, one of the topics that was discussed at the press conferences was that the Raspberry Pi had reached eight million sales. This makes it the bestselling British computer of all time, overtaking the Amstrad PCW line of computers. All of this has been

Below 2,000 of the original batch of Raspberry Pis as they were delivered in 2012

achieved in four years, with the vast majority of these Raspberry Pis built in the UK as well.

It seems the talk of sales during the launch of a new product didn't jinx anything, as the Raspberry Pi 3 went on to sell almost 500,000 units in March; the previous record was in March of last year, which saw the release of the Raspberry Pi 2. Looking at combined sales of all Pi models in March 2016, it was the bestselling month for the SoC computer in its history. You may remember that it took about a year for the Raspberry Pi to sell a million units, so this shows the increased reach the Raspberry Pi and its educational mission has achieved in the last three years.

With the possibility of different models of the Pi 3 coming out, it will be interesting to see how these exponential increases in sales affect the Raspberry Pi.

RECORD TO BEAT

The eight million number for the Raspberry Pi was a big milestone, confirming that the Raspberry Pi was the bestselling British computer ever. The next record to beat is the Commodore 64, which has sold anywhere between 12 million and 17 million units, depending on what data you believe. Actual sales data seems to suggest the 12 million number, whereas Commodore itself used to insist that the C64 sold 400,000 units a month consistently for a few years.



MILESTONES

The Raspberry Pi has been selling ever faster since its release

JAN 2013 1 MILLION SALES

With news that Premier Farnell had sold 500,000 Raspberry Pis itself, estimates for sales from RS Components suggested that a million had been sold in all, which was confirmed later. With the Raspberry Pi only launching in February of the previous year, it was an impressive achievement.

OCT 2013 2 MILLION SALES AND A MOVE TO THE UK

Nine months after breaking the million mark, the Raspberry Pi hit two million sales in the last week of October. 1.25 million of these Pis had been made in the UK at this point, eclipsing the overseas production of the original run.

FEB 2015 5 MILLION SALES AND A RECORD

Near the Raspberry Pi's third birthday, the Foundation received figures that confirmed the Raspberry Pi had sold five million units, becoming the fastest-selling British computer of all time. From a million in one year to four million over two years: the sales have been impressive.

PI WARS RETURNS!

The popular robot rumble is confirmed for another outing, but you'll have to wait until 2017

The past two Decembers have borne witness to tremendous robotic competitions of skill and power as part of the CamJam's Pi Wars. Mighty robots built by the community proved their worth through gruelling challenges such as following lines, bowling, and stopping at the right time. It's a huge amount of fun for those competing and spectating, so it's no surprise that a new Pi Wars has been announced.

Missing its usual December slot, Pi Wars 3 will be taking place on Saturday 1 April 2017. This change of date has been made for a very good reason, though.

"We decided to move it a few months to allow more schools to be able to compete," Michael Horne, co-organiser of the CamJams and Pi Wars, tells us. "We found that

instead of doing robot building during curriculum time (how naive was that?!), they were doing it in after-school clubs, and September to December didn't give them enough time. So, we hoped that we'd get more schools interested by giving them more time. We've so far had over 80 teams register their interest in competing and about a third are schools, so it would appear that the change of date has been successful – at least it has to the extent that there's interest!"

You can register your interest by heading to the Pi Wars site here: magpi.cc/25UHMEp. With new challenges such as the Minimal Maze, Pi Noon, and Slightly Deranged Golf, it should be a lot of fun. Check out our motor board reviews this issue if you're looking for some inspiration.



PREVIOUS CHALLENGES

Here's some of the things the robots had to do in Pi Wars 2



ROBOT DUEL

Taking a page out of *Mario Kart's* book, these Pi-powered robots duelled to the pop in this non-destructive battle to see which was the victor. The full details were kept secret until the day.

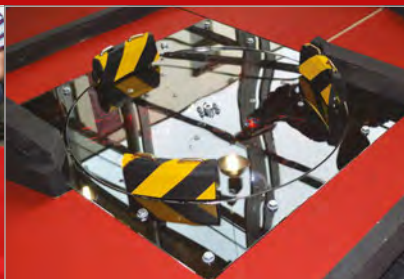

OBSTACLE COURSE

A classic test of manoeuvrability and skill as the robots needed to navigate a testing obstacle course, including the giant rotating platform created by PiBorg. It was more fearsome than it sounds.



STRAIGHT-LINE SPEED TEST

Your robot's gotta go fast in this speed challenge, testing out all its power in a sprint to the finish. More motors and wheels and a bigger chassis mean a heavier robot, though, so build wisely.



SEE CODERDOJO'S COOLEST PROJECTS

This Pi-vision system was designed to help blind people, using an ultrasonic distance sensor

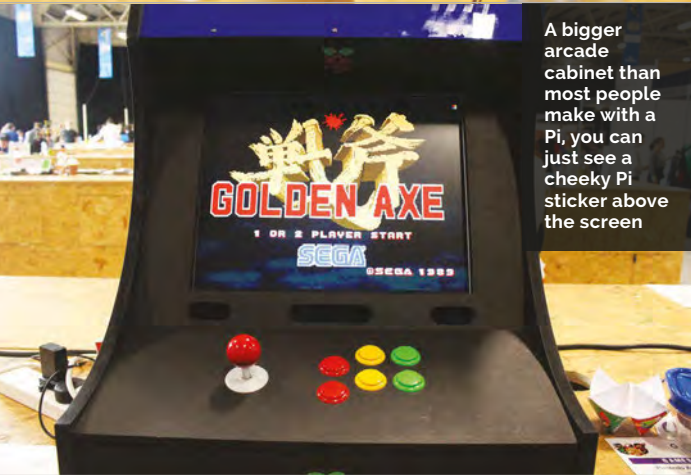

A bigger arcade cabinet than most people make with a Pi, you can just see a cheeky Pi sticker above the screen



Using mirrors and good code, a group managed to make a 3D experience in *Minecraft Pi*, with Sonic Pi linked up to it as well

Young people convene in Dublin to show off their best projects

On Saturday 18 June 2016, Raspberry Pi Foundation CEO Philip Colligan and community manager Ben Nuttall headed to Dublin for the CoderDojo Coolest Projects awards. Here, loads of young people gathered to show off their excellent projects for everyone to see. Philip gave a Pi-based presentation to start the morning, and then it was time to see the displays.

“As we walked around the venue, we grew more and more impressed by the projects on show,” Ben mentions in his blog about the event. “We asked each exhibiting group to talk us through their project, and were genuinely

impressed by both the projects and their presentation.”

There were a lot of Raspberry Pi projects on display, including websites, Sonic Pi demos, robots, and even an arcade machine:

“We arrived at a beautiful Pi-powered retro gaming console and spoke to the maker’s dad. He was excited for his son to be able to show his project to people from the Raspberry Pi Foundation, and asked if we could stick around to wait for him to return.” Ben requested Mega Drive classic *Golden Axe*, which was quickly loaded up for him to play. On this page are some of the amazing projects that Philip and Ben found.



Where there are Raspberry Pis, you’re sure to find robots. This one is controlled with a Wiimote

GET INVOLVED

How you can help inspire young minds

CoderDojo, like Raspberry Pi and Code Club, is all about inspiring and teaching kids about computing. Ben Nuttall has these tips on how you can help with this effort:

“If you want to join us in giving more young people the opportunity to learn programming skills, learn to make things with computers, and generally hack things that didn’t need hacking, there are plenty of ways you can get involved.

“You can set up a Raspberry Jam (magpi.cc/28Nxeff) in your area, or volunteer to help out

at one near you. Start a Code Club (magpi.cc/28NxbYz) at a local primary school, or another venue like a library or community centre. Finally, you could also set up a CoderDojo (magpi.cc/28Nxn2d), or offer to help at one near you.”

You can find out about any Raspberry Jams that might be near you by checking out our Events pages, starting on page 90 of this issue, or by checking the link for Raspberry Jams above for a full calendar of events. Maybe you’ll help inspire the next winners of CoderDojo Coolest Projects...

Become a coder, and your code could go to space in the next Astro Pi competition



Smarti Pi Touch

*Impossibly thin
Loves HATs
Versatile beyond belief*

Case for the Pi A+,B+,2,3 and Official Pi Touch Display



smarticase.com



pi-top

Worldwide shipping available in green or grey at www.pi-top.com

LEARN
PLAY
CREATE



pi-top



10 Hour
Battery Life



13.3"
HD Screen



Modular
Components

\$299 excluding VAT

pi-topCEED



Adjustable
Viewing Angles



14"
HD Screen



Modular
Components

\$99 excluding VAT

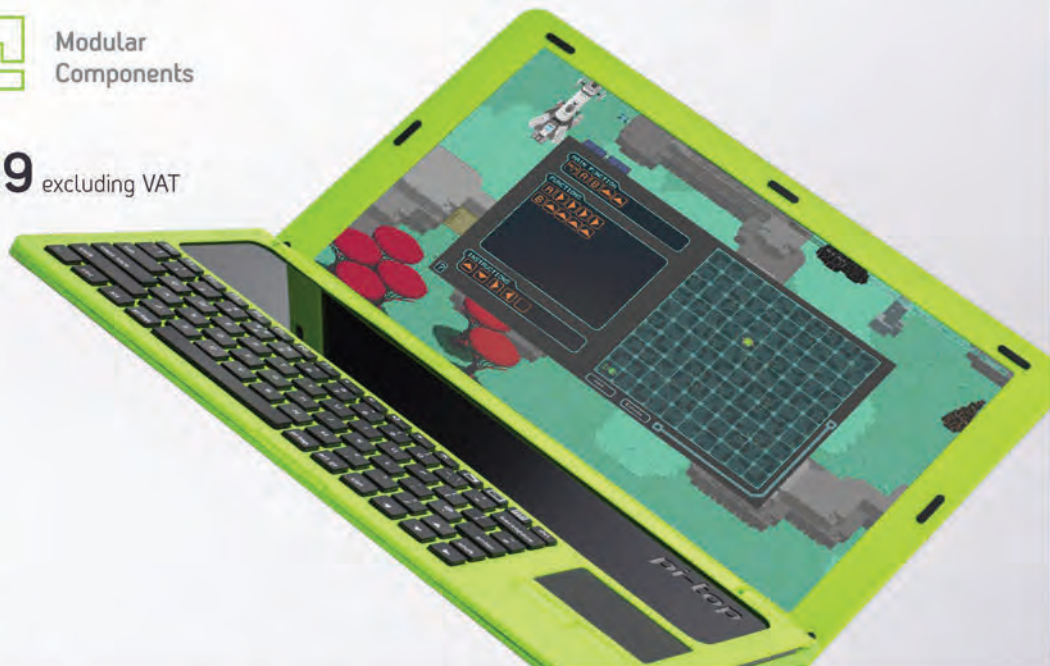

pi-top

Check out our education game CEEDuniverse at pi-top.com/learn
Stay up to date with our latest news by following our social media.



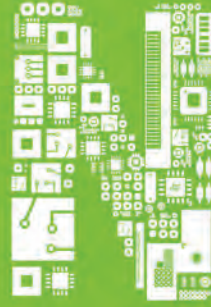
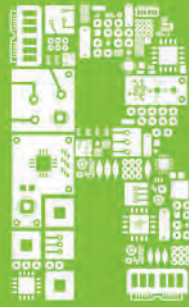

pi-topPROTO

pi-topPROTO is an Add-on Board for your pi-top and pi-topCEED. It allows you to prototype circuit boards, create amazing IoT devices and more. Slide the pi-topPROTO into the modular rail to build any functionality into your device.

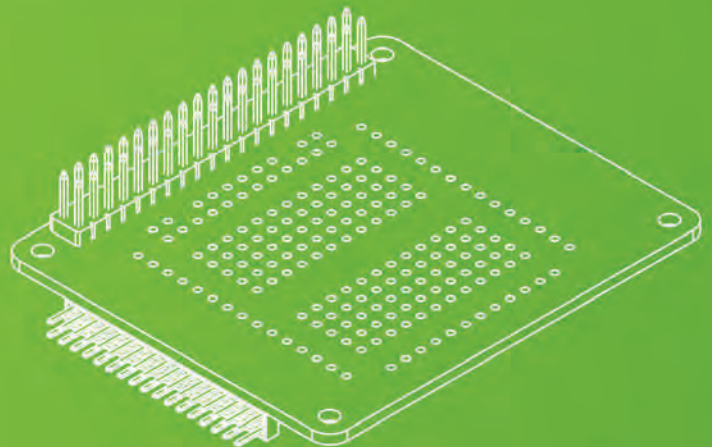

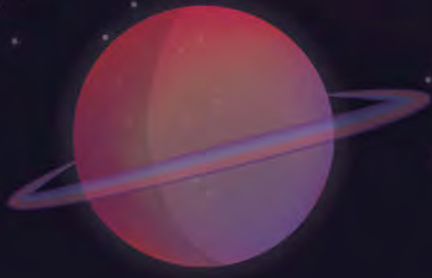

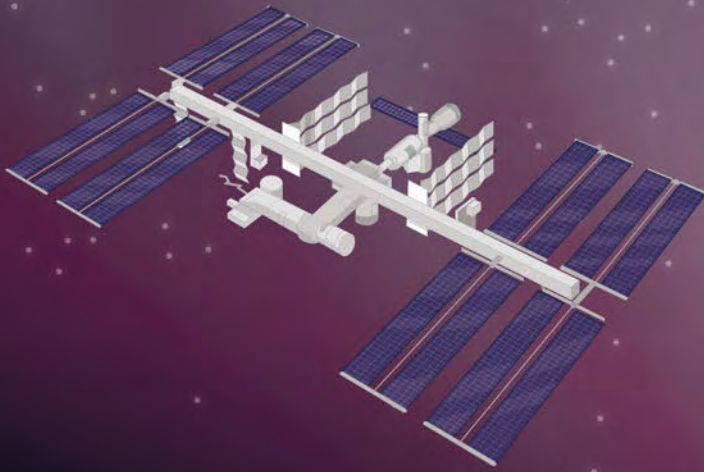

Mission

ACCOMPLISHED

Over the past six months, the eyes of the nation have been turned skyward, hoping to catch a glimpse of the ISS as it zooms far overhead. It's not the space station that people are looking at, though; it's the man on board representing the United Kingdom. Passions have been ignited and many people have been inspired, thanks to the endeavours of British ESA astronaut Tim Peake.

Tim wasn't the only UK passenger aboard the ISS; as we're sure you've seen in this magazine, two special Raspberry Pis joined him up there. The Astro Pis, Ed and Izzy, had their own mission to carry out experiments coded by British school students, some of which Tim helped with, and the results have been phenomenal.

On 18 June, Tim finally returned to Earth, and told reporters, "It was incredible. The best ride I've been on ever." While his first space flight is over, Ed and Izzy's ride isn't just yet, as the Astro Pi adventure continues. Here's what they've achieved so far.

TIM PEAKE'S COSMIC classroom

Imagine being a child back in July 1969, when humans first set foot on the Moon. Watching those grainy black-and-white TV images would have been both fascinating and inspirational, and many a kid would have gone to bed that night dreaming of becoming an astronaut.

Since then, space exploration has come on in leaps and bounds. Scientists are making exciting new discoveries and there are faraway plans to put people on Mars. But what's perhaps just as interesting is that we don't have to be idle participants any more. Thanks to the Raspberry Pi, children can engage with space like never before.

It wasn't always going to be that way. When plans were made for ESA astronaut Tim Peake to travel to the International Space Station last December, the idea was that he would solely work on a twin-expedition, educational mission called Principia (principia.org.uk). It involved conducting experiments which can't be carried out anywhere on Earth, looking at physiology, biology, and materials science, as well as solar and radiation physics.

But then the UK Space Agency proposed sending Raspberry Pis to the ISS with him, allowing children to conduct their own space experiments. The concept of the Astro Pi and its associated competition was born and – a week

18 June may have seen the end of Tim Peake's 186 days in space, but this is only the end of the first chapter for Astro Pi



Tim worked on many science experiments while in space and especially in the ISS's Columbus module, home of Ed

before Tim made his voyage and following 20 months of intense work – two Pis equipped with the sensor-packed Sense HAT were sent skywards.

Each Pi had a different camera – a standard visible spectrum and an infrared – and children were invited to code them, with the promise that the best efforts would be uploaded for use by Tim. At their disposal was an all-in-one gyroscope, accelerometer and magnetometer, the Sense HAT's 8x8 RGB LED matrix and temperature, humidity

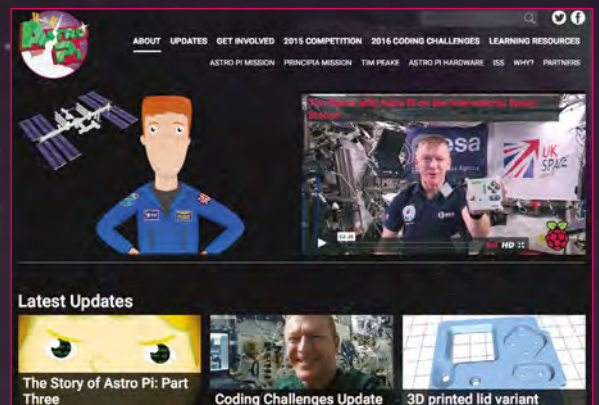

For more information on the individual experiments, and to watch the Astro Pi video series, head to astro-pi.org



In space, everyone can see your selfie Credit: ESA/NASA

and barometric pressure sensors. The children used them to come up with some marvellous experiments.

The winners

In total, seven experiments were chosen: two winners from students aged 11 and under, two from those 11 to 14, two more from 14 to 16, and one from 16 to 18. Each winning experiment fitted well into Tim's

fun. Team Terminal from Lincoln UTC produced a suite of reaction games that could gauge how Tim performed over time, and whether he was affected by long-term space flight. 'Flags' used telemetry data provided by NORAD, together with the real-time clock on the Astro Pi, to predict the ISS's location. It then displayed a flag of the country directly beneath the ISS.

“ Each winning experiment fitted well into Tim's overall remit of research ”

overall remit of research, and they astounded the judges. 'Crew Detector' by Cranmere Code Club, for example, was able to check for fluctuations in humidity in order to see if an astronaut was nearby, while 'SpaceCRAFT' took data logs from the Astro Pi sensors and visualised the results in *Minecraft*.

'Trees' took images of Earth in order to analyse plant health; 'Watchdog' by Kieran Wand measured temperature, pressure and humidity, and displayed them on the LED screen for astronomers to check; and 'Radiation' by Team Arthur, Alexander and Kiran at Magdalen College School blanked off the visible spectrum camera so that only high-energy space radiation could get through, allowing for effective monitoring. Of course, there was room for

“Flags was this simple thing that allowed astronauts to look out of their window and know where they were orbiting over,” says Libby Jackson from the UK Space Agency. “The children worked out how to do that using three-line element data and it was a great example of what the project could do.” Libby was amazed by the creativity on display and the way young minds solve problems. “They came up with things that blew our minds; things that we had never thought of”.

Peake practice

The experiments ran during February and March, and they were classed as prime activities. This meant they were carried out as part of the four hours in the mission set aside for educational pursuits. On top of that, Tim could use his

MUSIC TO TIM'S EARS

Space is great, but it's tricky to update your MP3 player from the ISS. Dave Honess sprung into action to provide Tim with some fresh beats by launching a new competition. This 2016 Coding Competition tasked students with turning the Astro Pi into an MP3 player, or to produce some original music using Sonic Pi (sonic-pi.net).

PLAY THAT FUNKY MUSIC

Lowena Hull's MP3 player allowed Tim to shake the Astro Pi to adjust the volume and skip tracks. "I was dubious about the tilt mechanism working well in microgravity using the accelerometers to change tracks, but it worked brilliantly," Tim says. "I tried inputting motion in other axes to test the stability and it was rock solid - it only worked with the correct motion." But all were amazing: Marcus Panchal's iSpace showed playback progress, Joe Spears' MP3 player included a *Red Dwarf* alarm clock and cool patterns, and Jude Young's Astro MP3 Player had functional buttons and LED patterns.

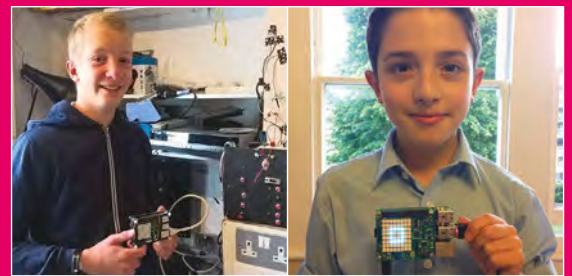

Joe Spears' MP3 player had a *Red Dwarf* theme

Jude Young was the creator of the Astro MP3 Player

LET'S JAM

The Sonic Pi tunes were great, too. Pinal Parmar came up with *Keep Calm and Dance*, while Iris and Joseph Mitchell of the Southend Raspberry Jam produced *Run To The Stars* and included a funky piano, bass drums, cymbals, squelchy bass, and 'alien tune' loops. Isaac Ingram's *Final Frontier* was complex ("The key was to make the drum beat and then develop the music around it," explains his father, Karl), while the development of Jamie Andrews' Piano Pi "was based around the chords used throughout," says his father, Jason.



The Mitchells produce their Sonic Pi track, *Run To The Stars*

The creator of *Final Frontier*, Isaac Ingram, started with a drum beat and built the song from there

SKY-PI THINKING

Astro Pi has encouraged children to think about the importance of coding within the space industry. Libby Jackson, the UK Space Agency’s astronaut flight education programme manager, says: “Pis have been used in satellites, the ISS

has computers with millions of lines of code, software is needed for the next Mars Rover, and we need solid programs for the service module for the Orion spacecraft. There are lots of opportunities.” Libby is actually the one to thank for Astro

Pi’s existence in the first place; when she was interviewed for her job at the UK Space Agency, she pitched an idea for doing something with Raspberry Pi on the ISS. This kernel of an idea is what eventually became Astro Pi.

reserve activity time – another four hours which, as long as there wasn’t a pressing emergency, was available for any Pi projects if he so wished. But Tim also used Astro Pi during his days off. It underlined the fact that Tim loved his time with the Raspberry Pi and that it has proven to be useful.

“That’s where Astro Pi got a big win,” says Dave Honess, education resource engineer at the Raspberry Pi Foundation. “Tim was motivated and interested in Astro Pi, and he engaged with it himself on a personal level.” Whenever Tim used the Pi, Dave would get a daily operations report from the ground control team, detailing what he had done. “There may have been other things he was doing in his own time, such as using the suite of reaction games,” Dave says. “We know he was very engaged.”

To ease the burden on Tim’s time, the programs ran automatically.

Tim simply had to select an experiment from an app called the Master Control Program, which was on board the Astro Pi. But he threw himself into the tasks,

using social media and videos to showcase what he was doing with the children’s work.

“I’ve been amazed at how many kids and adults have been



Credit: ESA
Here’s Ed, codename Astro Pi Vis, after he was unpacked, ready to start running some experiments in the name of science



EXPERIMENT	DATES	ASTRO PI USED	WHERE?
Crew Detector	2 February to 9 February	Visible spectrum camera	Columbus module
SpaceCRAFT	9 February to 16 February	Visible spectrum camera	Columbus module
Flags	16 February to 23 February	Infrared	Node 2
Trees	23 February to 25 February	Infrared	Node 2
Watchdog	29 February to 7 March	Visible spectrum camera	Columbus module
Reaction Games	03 March to 3 March	Visible spectrum camera	Columbus module
Radiation	7 March to 14 March	Visible spectrum camera	Columbus module



Credit: NASA
Tim Peake is now back on Earth and is going through debriefing. Hopefully he'll return to the ISS, where Ed and Izzy will be waiting

encouraged and inspired to take up programming and look at science in a different way," effuses Tim. "Libby told me that the UK Space Agency has now engaged with over a million school children during this mission, and

" I've been amazed at how many kids and adults have been encouraged and inspired to take up programming "





of course Astro Pi has been a huge part of that."

One person who is certainly pleased at how well Astro Pi did is Raspberry Pi founder Eben Upton, who said the entire experiment reminded him of the excitement he felt about space as a child back in the 1980s. "Inspiring a new generation of scientists and engineers has always been a key part of the Principia mission, and Tim made space travel as cool for British children today."





Eben believes it showed the great potential of commercial, off-the-shelf technology in space applications. "We hope to see Raspberry Pi-derived hardware in CubeSats in low earth orbit and maybe beyond: we've been wondering if SpaceX have any room on their Red Dragon mission in 2018," he comments.

Given that the Astro Pi was one of the fastest ever projects deployed to the ISS, you sense anything is possible.

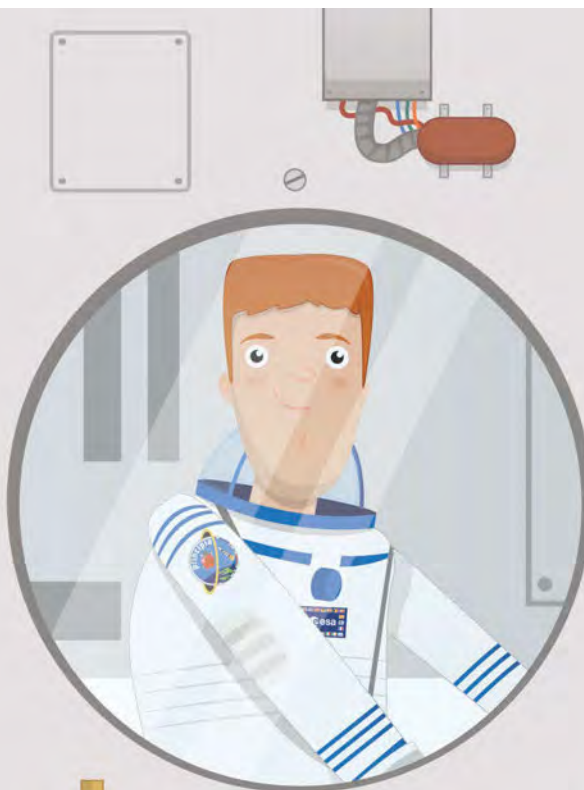
DAY IN THE LIFE OF AN ISS ASTRONAUT

- 
6am
 Astronauts work to the GMT time zone. They wake at 6am in their soundproofed cabins, have breakfast, and catch up with messages.
- 
7.45am
 Daily planning conference begins with the astronauts talking through the tasks ahead.
- 
8am
 Work starts on science experiments and other duties set for them.
- 
11am
 Exercise is crucial to avoid muscle wastage.
- 
1pm
 Lunch



- 
2pm
 More science experiments are performed as work continues after lunch.
- 
6pm
 An extra exercise session caps off the astronauts' working day.
- 
7pm
 Second daily planning conference to discuss the day's events.
- 
7.30pm
 Meal and leisure time. Astronauts watch TV or work on cool stuff such as Astro Pi.
- 
9.30pm
 Time to sleep.

SPACE *craft*

Replicating the movements of the ISS and its environment in a Minecraft world

Infobox

Creators

► Hannah Belshaw, at Cumnor House Girls School

Dates

► 9 February to 16 February 2016

Astro Pi

► Astro Pi Vis

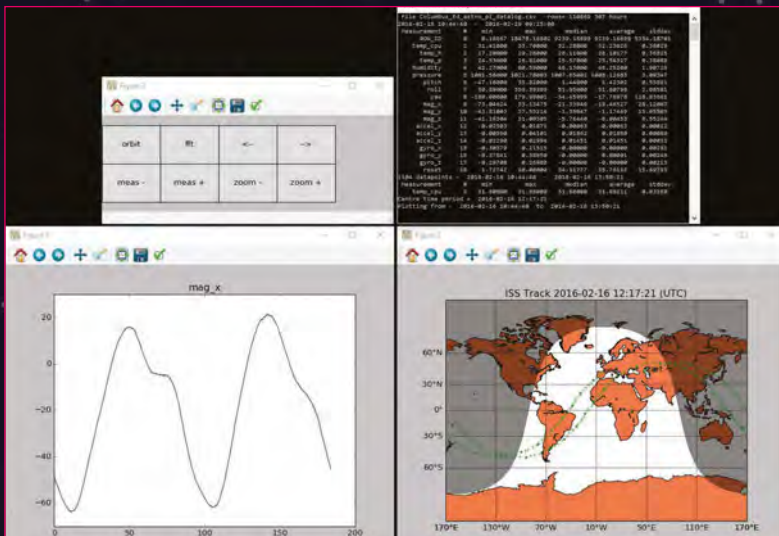

A look at the collation of the data as it came through via the SpaceCRAFT experiment

In order to better understand a complex concept, bringing it back down to earth can help enormously. And so it proved when Jon Belshaw was talking to his daughter, Hannah, about space, the ISS, and the ability of the Astro Pi’s magnetometer to measure the Earth’s magnetic field. “Can’t we just do it in *Minecraft*?” she asked him, firmly seeding an idea that would grow to be a winner.

Jon had already shown Hannah how to program blocks in Python,

and create shapes such as spheres of sand which dropped under gravity in *Minecraft*. But with SpaceCRAFT, the concept was to log information from the Astro Pi’s sensors every ten seconds, laying down row upon row of data in a CSV file. Upon the return of the document from orbit, Hannah envisaged opening it in *Minecraft* and playing it back, effectively using the block-building game as a data visualisation tool.

To advance the idea, Hannah had a Skype meeting with Martin

O’Hanlon, a Picademy trainer and co-author of *Adventures in Minecraft*. She discussed writing Python code to animate a small version of the ISS and animated gauges for the environmental sensors. There would also be a long-term data logger and a playback function. Martin wrote the code and sent it back to Hannah for her to look at.

When the code was ready, it was sent to the ISS. “It was a gateway idea, because children love the open-world nature of *Minecraft* and the ability to freely construct their own world,” says Jon Belshaw. “The ability to build in *Minecraft* with Python code shows children they don’t only have to consume technology, they can actively produce it themselves, which is a powerful lesson for them.”

Expected results

According to Jon, the idea was to make young people think about science and technology and engage with it more directly. “They can think about what microgravity means, and the distances, speeds, and energy required to lift someone up to

Hannah says

“ I had some amazing experiences because of this project, like starting my own coding club at my school, visiting Surrey Satellites, and best of all being able to meet Tim Peake

THE SCIENCE

There were three main components to the SpaceCRAFT experiment. During its development, Hannah Belshaw sought to collect and use data that would look at the internal environmental of the ISS, allowing it to monitor pressure, temperature, and humidity. The experiment also sought to look at the microgravity environment by using the accelerometers of Astro Pi. Finally, it was envisaged that it would analyse the magnetic environment, including any local effects and the Earth's magnetic field. Hannah's father, Jon, has also coded an Astro Pi data browser, which you can see by visiting magpi.cc/1rvC4WA.

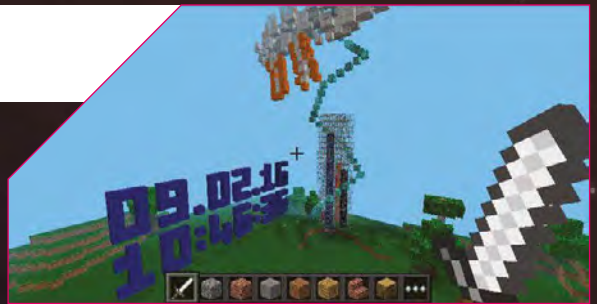

A CSV spreadsheet file was created from the raw collected data, which could be loaded into *Minecraft* to produce a visual representation

some amazing animated visuals within the game. “There’s a big blocky ISS in the sky that tilts and rolls, depending on what it was doing according to the data,” explains Dave Honess, education resource engineer at the Raspberry Pi Foundation.

“The internal environment can be seen, and you can see a variation as the ISS goes in and out of sunlight,” Jon adds. “The most obvious result is the Earth’s magnetic field, which is clearly seen varying with the orbit. We didn’t see an obvious acceleration event, which shows how good the microgravity environment is on the ISS.”

Hannah’s success in the competition also led to her new school, Lingfield Notre Dame, setting up a Code Club, introducing a whole year of children to Astro Pi coding.



space,” he says. Both he and Hannah expected to see “mainly internal effects”, although they also hoped to see “the occasional engine burn as acceleration”.

Results

SpaceCRAFT was a resounding success, laying down 60,481 rows of data in a mammoth 25MB CSV file. It allowed for



Here’s Hannah, the creator of SpaceCRAFT, with a test Astro Pi flight unit

CREW detector

Snapping away at astronauts on board the ISS by detecting changes in humidity

Infobox

Creators

> Cranmere Code Club, at Cranmere Primary School

Dates

> 2 February to 9 February 2016

Astro Pi

> Astro Pi Vis



When the Crew Detector felt someone's presence, the astronaut – invariably Tim – could press a button and pose for a picture



The head Russian cosmonaut, Mikhail Kornienko, is captured by the Crew Detector



Here, Tim has been caught in action – if the Crew Detector was left long enough, it snapped a photo without being asked

Originally called Sweaty Astronaut, this fun project sought to use the environmental sensors of the Astro Pi to detect the presence of a crew member on board the ISS. By monitoring fluctuations in the humidity sensor, a message would scroll across the LED screen asking if someone was there. A picture would then be taken using the camera, and the idea was to see how many shots it would eventually be able to capture.

The concept for Crew Detector came from Cranmere Primary School pupil, Jasper Hayler-Goodall. He, along with all members of the Cranmere Code Club, had been encouraged by teacher Richard Hayler to submit an entry to the Astro Pi competition. When the club found it had won, the children decided to code the experiment themselves, and it made for a true collaborative effort.



“I still can't quite believe that the code we wrote in the computing suite at the school has been run on the ISS,” says Richard. “The Cranmere boys and girls were determined from the outset that they would do it themselves when – and not if – they won. I was also impressed by their attention to detail, especially the usability of the program. They clearly felt a real sense of ownership over the code, and wanted it to work they way they thought best.”

Expected results

The team members didn't have a set number of expected

THE SCIENCE

The project sought to test the theory that in a tightly controlled environment such as on the ISS, the presence of an astronaut would increase the local relative humidity enough that it could be detected through changes in the readings reported by the Pi's Sense HAT. Since the Sense HAT is able to measure relative humidity – that is, the amount of moisture in the air compared to what the air can 'hold' at that temperature, given as a percentage – the Cranmere Code Club believed the sensors would be able to pick up any fluctuations. It was thought that a passing astronaut could be detected because humans affect the amount of humidity in the air when sweating and exhaling.



Cranmere Code Club proudly show off their Astro Pi certificates

photographs in their head, but they implemented measures that would help to increase their chance of success. So, while the code would try to catch an astronaut's attention if it believed one had been detected, prompting them to pose for a photo, if it was ignored then the AstroPi would snap away regardless after a few seconds.

The resulting data was logged in a file. "We were hoping to be able to plot graphs of humidity readings and see spikes indicating a change in humidity," Richard adds. "The times of the peaks should correspond to time-stamped photos containing a friendly spaceman." As a neat bonus, the Sense HAT's LED matrix would display a three-minute animation sequence, created by the dozen-strong Code Club, upon a positive detection.

Results

It was always going to be a difficult project. As Richard points out, the code would have to record the baseline humidity just long enough to produce an accurate trigger threshold. The children also had to consider the trigger point: if they set the bar too high then it would fail to detect anyone, and if it was too low it would create too many false positives. This had to be done without truly knowing the conditions of the ISS.

But in the end, they received nine photographs of British ESA

astronaut Tim Peake either posing or working, in addition to one showing just his arm. Another image showed Russian cosmonaut Mikhail Korniyenko's head in the distance. "We had lovely clean plots of humidity with a number of peaks every day, and each of the corresponding photos has an

astronaut in it," says Richard. The children presented their results to a large auditorium of people at the Pi birthday party in March.

"The images were mostly Tim setting it off," says Dave Honess. "But that's because it was set up in the European Columbus module where Tim works."

" We had lovely clean plots of humidity with a number of peaks every day "

Jasper Hayler-Goodall came up with the idea for the Crew Detector entry



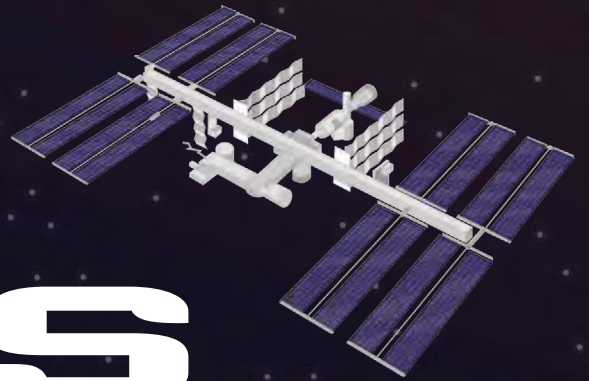

trees

Mapping the environmental health of Earth in great detail from the ISS

Infobox

Creators

> EnviroPi, at Westminster School

Dates

> 23 February to 25 February 2016

Astro Pi

> Astro Pi IR



One of the advantages of considering the wider implications and applications of space is the ability to think big and see the overall picture of life. Oliver Turnbull certainly thought so, as he took inspiration from people who were using the Raspberry Pi and its infrared camera to monitor environmental change through the measurement of plant health. “I thought this could be taken to the next level and be done in space,” he says. And so the Westminster School pupil proposed Trees, which looked to use the Astro Pi NoIR camera to snap pictures of the ground.

It was obvious that it was going to be an ambitious project from the start. Under the team name EnviroPi and the watchful eye of teacher Sam Page, Trees was looking to achieve something that’s normally performed by sensitive and expensive devices. “By doing this with the extremely cheap Raspberry Pi, I hoped to show its power in monitoring environmental change and damage, and encourage others to set up their own DIY projects in helping to monitor it,” Oliver says.

To do this, the infrared camera was used to take observation pictures of the ground and then an image processing technique called Normalised Difference Vegetation Index (NDVI) was used.

Essentially, this is a measure of plant health. Oliver thought it would be interesting to compare the global data collected from the ISS to other environmental metrics, such as CO₂ emissions or annual temperature, which can be found online from the World Bank API.

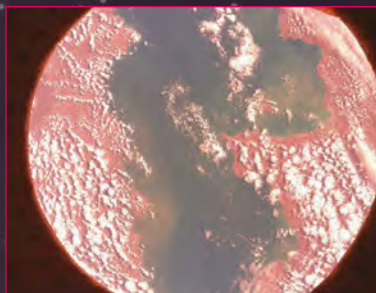
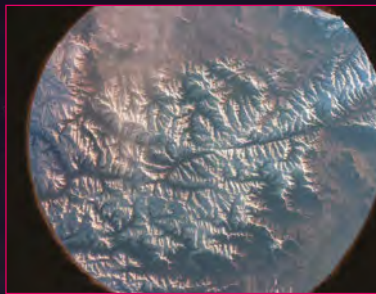

This snapshot of Earth shows the plant health above central Europe, taken on 23 February

Amazing colour was captured by the camera in this image taken over Central America

THE SCIENCE

The experiment sought to investigate the plant health level of vegetation across as much of the world's surface as possible, by examining the present levels of chlorophyll and comparing it against several environmental factors for each area. Chlorophyll strongly absorbs light in the 400-700nm band (visible light), but reflects strongly in the near infrared band. The photosynthetic capacity (that is, the chlorophyll levels) of a plant can then be worked out by comparing the ratio of near infrared radiation reflected to visible radiation reflected. A special index called NDVI gives a value from +1 (most photosynthetic) to -1 (not photosynthetic). Forests will have a very high value for NDVI, while areas such as oceans or deserts will have a negative value.

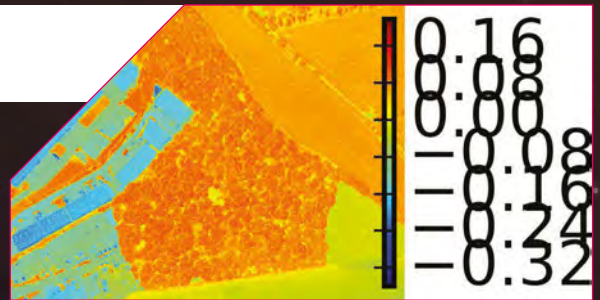

But it meant the red and infrared data would be saved to the same channel, making it impossible to distinguish the latter. “We had to improvise by using an alternative index (GLI), which compares the green channel to the red channel $(G-R)/(G+R)$,” Oliver reveals.

Despite the setback, more than 4,000 photos were sent back. And they were stunning. “Although there’s less definition than with the NDVI method, it still shows some definition. I am still playing around to try and optimise the images and to improve the definition, such as taking into account atmospheric corrections, but hopefully there will be some nice data in the end.”

Expected results

Oliver had done his homework: he took off in a light aircraft to test the experiment, holding the camera out of the window. He was able to process the resulting images and get an idea of what it would be like with the benefit of more altitude. Oliver expected to see a negative correlation between NDVI levels (or plant health) in different areas and the amount of CO₂ emissions and average fluctuations of temperature in those areas.

“We also hoped to get some strong definition between different areas of land (for example, very dense forest, rainforest, agricultural land, forested land) to demonstrate the ability of the Raspberry Pi as an ecological monitoring device,” Oliver adds. “In my tests, we managed to get some really strong definition between different areas of land.”

Results

Trees didn’t run as smoothly as expected. In order for the experiment to work, a blue filter needed to be applied to the camera, but it didn’t form part of the payload to the ISS. It was an essential component, and it looked like the project would be doomed (the astronauts even tried to find a blue filter on board). In the end, the Astro Pi was deployed onto the hatch window and ran without it.



Credit: ESA
In order to get a good image of Earth, Tim Peake stuck the Astro Pi IR device onto the hatch window of the ISS

Oliver says

“Hopefully this will help to inspire others to take environmental monitoring into their own hands. It’s pretty amazing to think that [Raspberry Pi] can perform the job of something worth hundreds of thousands of pounds



TO INFINITY and beyond

The future of Astro Pi is very bright

Tim has returned to Earth and been reunited with his family. His legacy will carry on, though, thanks to the kids he's inspired over the past six months, and there's a very real possibility he'll be able to go up to the ISS again. As for the Astro Pis, their legacy is just beginning as they'll be up on the space station for a very long time.

"The Astro Pis are staying on board the ISS until 2022," Dave Honess tells us. "That's when their RTC batteries technically expire, although they'll probably hold charge for another ten years. At that point, we'll get them down from space and retire them to a comfy museum somewhere so everyone can go visit them!"

While the Astro Pis were created with the aid of the UK Space Agency with Tim's stay in mind, their ability to stay operational for another 6-16 years on the ISS means that other plans sprang up for them. In March 2016, the ESA got in contact with the Foundation

Want to get your hands on an Astro Pi? You can start 3D-printing your own flight cases to do some experiments with



about the Astro Pi being involved with French astronaut Thomas Pesquet's mission on the ISS.

"The ESA has Astro Pi educational plans for the next two astronauts that are going up," Dave reveals. "Thomas Pesquet is launching in November this year,

and veteran [Italian] astronaut Paolo Nespoli launches in May 2017."

It's not just France and Italy who will get involved with Astro Pi, though. Thanks to the success of Astro Pi, the ESA is rolling out Astro Pi-related education resources to all ESA member states, which is currently 22 countries, exponentially expanding the educational reach of the Astro Pi project.

"Each ESA member state has something called an ESERO office; these provide free resources, support and information for teachers to enhance STEM subjects using space as a context," says

"The ESA has Astro Pi educational plans for the next two astronauts that are going up to the ISS"

"

Dave. “We’re working with ESA to distribute hundreds of boxed Astro Pi kits around Europe through these ESERO offices. They will have a range of supporting educational material in the local languages, so they could be coming to a school near you!”

There’s not just educational plans for the Astro Pis either – their usefulness hasn’t gone unnoticed by the rest of the space agencies that make use of the ISS, as Dave explains:

“ESA operations are also planning to use the Astro Pi payload for a number of utilitarian, non-educational applications. These plans are currently in flux, but may represent a more longer-term use for the payload for when there are no ESA crew members on board the ISS. One idea is for them to be ‘delay-tolerant networking download servers’ for the JSL. Downloading large amounts of data to the ground usually ties up a laptop, but because the Astro Pi OS is a derivative of Debian Linux, they can easily be configured for this task. They would have a large USB hard disk connected, which would be shared over the JSL network,

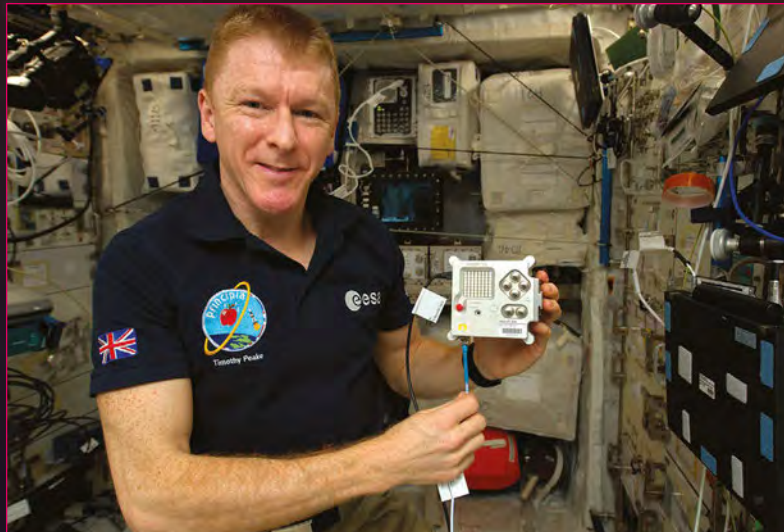

Credit: ESA/NASA

GROUND CONTROL TO ED AND IZZY?

On 9 June 2016, Tim Peake connected one of the Astro Pi computers to the ISS Joint Station LAN using a £4,000 Ethernet cable, whereupon it was remotely accessed by ground control in Switzerland. To accomplish this, a double VPN is used along with a Ku band radio link bounced off a number of satellites in orbit. Firstly, they VPN into the ESA private network, and from there they open another VPN across the Atlantic to a NASA computer called the MPCC ground node. That machine uses the Ku band radio link and has IP connectivity to everything on the ISS Joint Station LAN. Basically, you can now talk to the Astro Pi from a computer on the ground.



Putting on events around the country so kids could talk to Tim; parts of the ARISS system used Raspberry Pis such as the display here

ENTRANT DATA

Teams from all around the UK entered the Astro Pi competitions, and school students everywhere were inspired by this and Tim Peake's mission

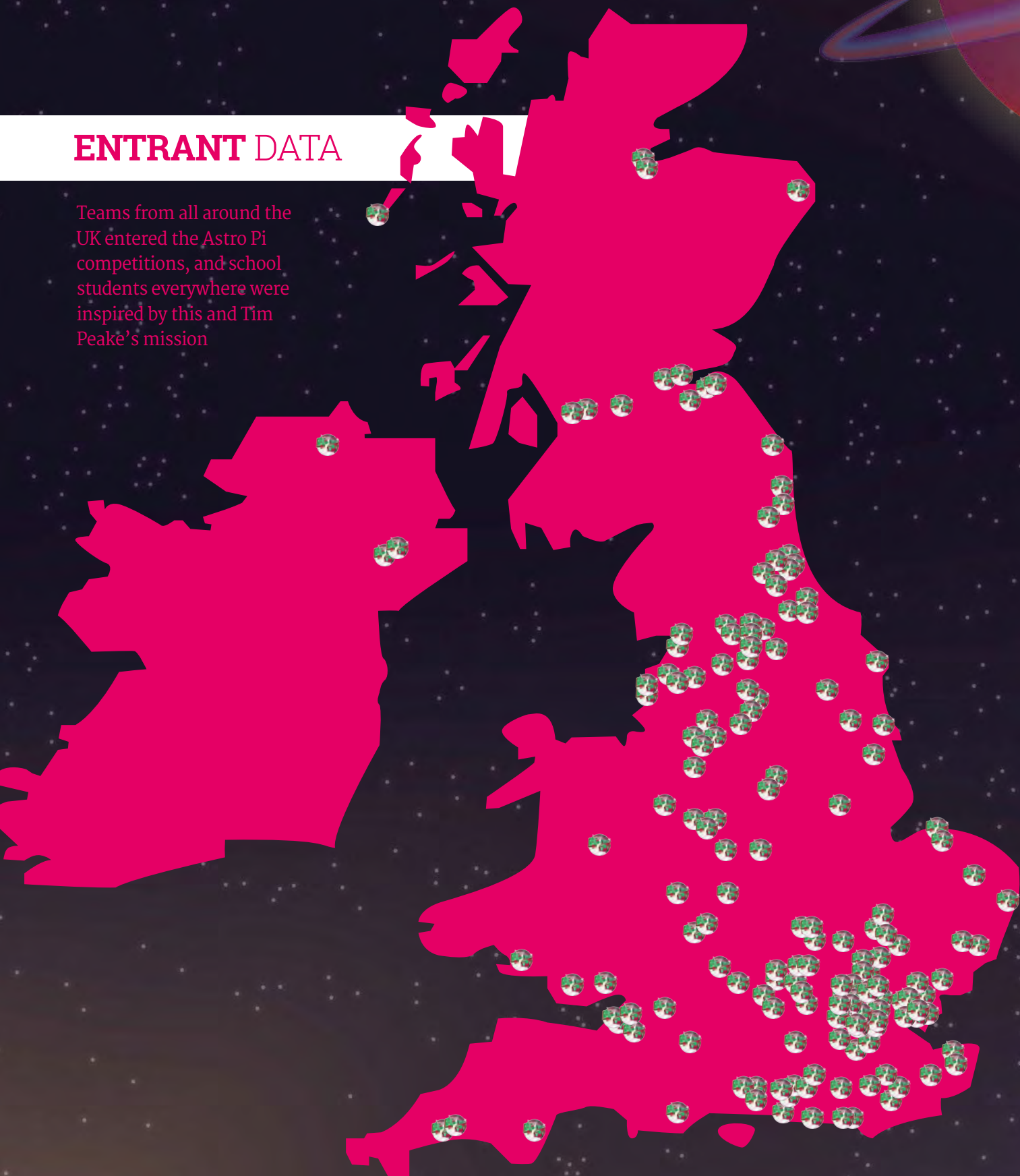

Judging was difficult with so many excellent entries; however, there will be many more competitions to come for Astro Pi



“ This won’t be the end of Tim’s relationship with the space-venturing Pis ”

and anything copied over by the crew would be slowly synchronised to the ground... This means the payload would be contributing to the daily operations of the ISS, and could pave the way for more Raspberry Pi hardware in the future.”

The next stage of Astro Pi for the Foundation is the roll-out of Astro Pi kits and educational resources to the other ESA countries, as mentioned. This involves translating resources

into multiple languages, as well as doing competitions in the other countries, so Dave’s work is still very much ongoing even though the first phase has ended.

“I can honestly say that Astro Pi is one of the best things I’ve contributed to,” Dave tells us. “It’s been a huge collaborative effort from the start. It’s had input from educators, designers, engineers, aerospace companies, and international space agencies. For me it’s been hugely gratifying to see all these different people pull together in the name of education.”

Even with Astro Pi becoming a Europe-wide educational mission, this won’t be the end of Tim’s relationship with the space-venturing Pis.

“When Tim Peake flies again (when, not if), we would love to build a brand new Astro Pi for him. It would be faster, better, with more LEDs, more sensors, and more buttons, and would allow a wider range of experimentation for budding programmers.”

We can’t wait to return to the final frontier for more experiments with Ed and Izzy.



French ESA astronaut Thomas Pesquet will be the next face you see working with the Astro Pi

ASTRO INSPIRED

Here’s some Raspberry Pi space projects that have come about since Astro Pi

ARISS

ariss.org

ARISS lets students around the world experience the excitement of talking directly with the crew of the ISS via ham radio. They’re looking to fly a third Astro Pi to act as a dedicated composite video source for the ham TV, so students can watch the astronauts talking on the radio.



Credit: Norwich School

RASPBERRY PI FOR SPACE APPLICATION

tesat.de/en

Tesat-Spacecom is a German aerospace company which is investigating the possibility of qualifying Raspberry Pi computers as a standard aerospace part (MIL-PRF-38535, ESCC9000, EEE-INST-002). This could enable things like the Pi Compute Module to be used as a generic part on many different spacecraft and satellites in the future.



Credit: Tesat-Spacecom

MAMMOTH-UP

mammoth-up.eu

MaMMoTH-Up is a research project developing an experiment container for payloads launching on Ariane 5 rockets. The container and the experiment inside it are controlled by a computer that provides access to the rocket’s flight telemetry. Airbus DS has employed an intern to use a Raspberry Pi as the dummy payload to test this interface.



Credit: Arianespace

FREE PI ZERO!

Subscribe in print for six or 12 months to receive this stunning free gift

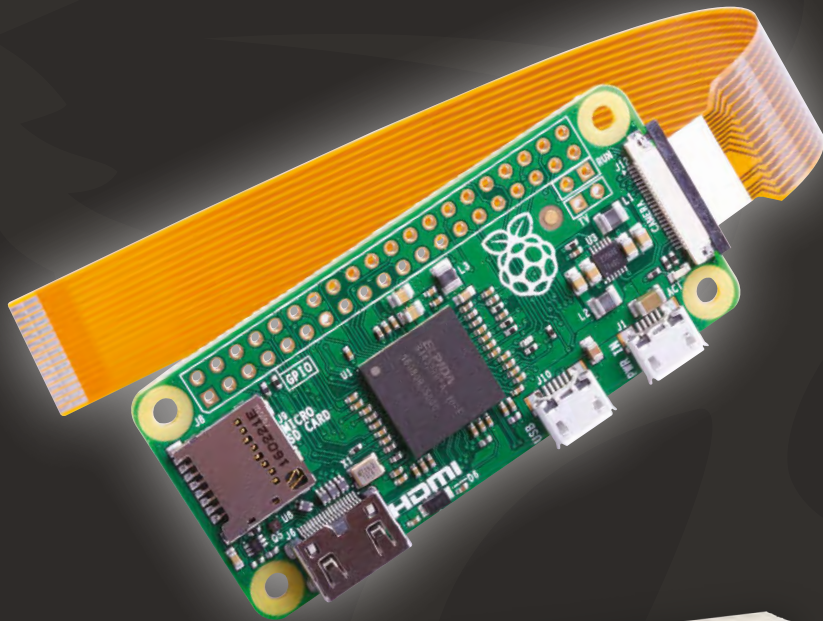

Subscribe today & receive:

- A free Pi Zero v1.3 (the latest model)
- A free Camera Module connector
- A free USB & HDMI cable bundle

Delivered with your first issue!

Other benefits:

- Save up to 25% on the price
- Free delivery to your door
- Exclusive Pi offers & discounts
- Get every issue first (before stores)



SAVE
UP TO
25%



MARTIN MANDER

Martin is a business intelligence analyst with a passion for converting vintage technology into new creations using modern components, especially the Raspberry Pi. magpi.cc/1U61EvA

A recycled USB internet phone acts as a digital microphone and is wired to the Trimphone's handset

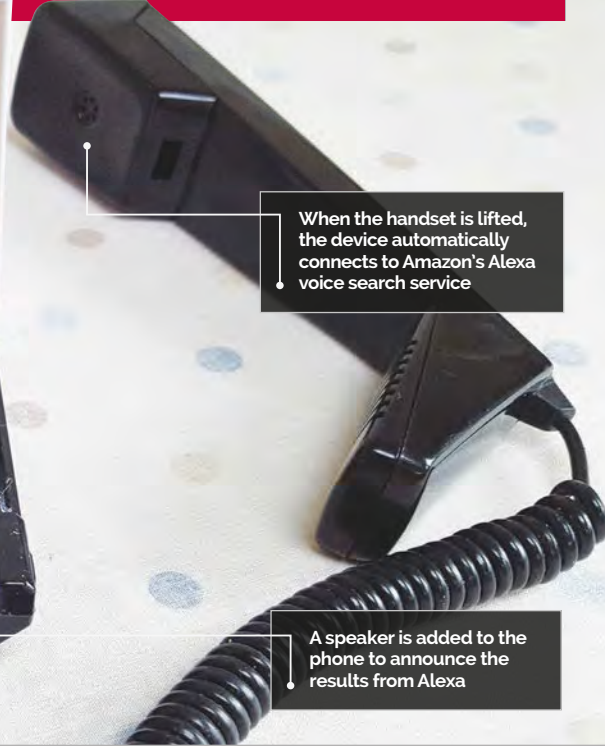
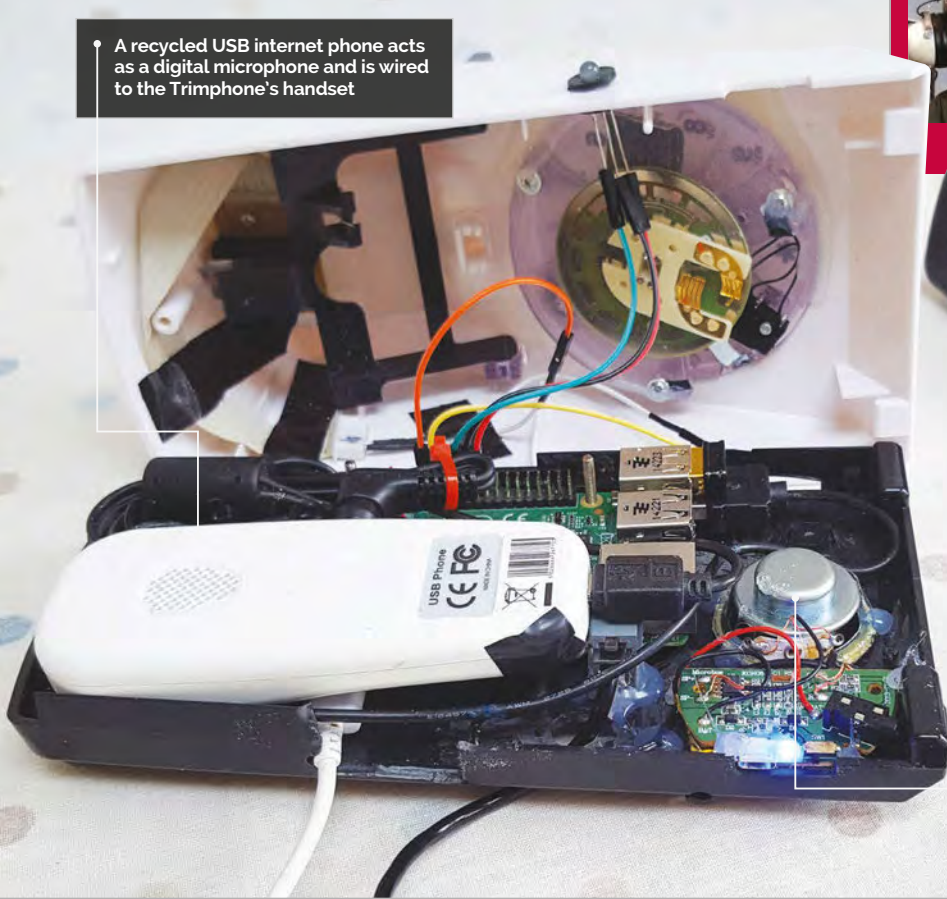

When the handset is lifted, the device automatically connects to Amazon's Alexa voice search service

A speaker is added to the phone to announce the results from Alexa

Quick Facts

- ▶ The AlexaPhone took two weeks to build
- ▶ Alexa uses natural language processing AI to answer questions
- ▶ AlexaPhone only takes two seconds to respond
- ▶ The Trimphone's dial contains a tiny amount of radioactive tritium
- ▶ Around 1.6 million Trimphones were sold in the 1970s

ALEXAPHONE

The Raspberry Pi inside this 1970s telephone calls up Amazon's Alexa voice assistant and gets the answers to almost any question

A pirate-themed speaker was dismantled to provide the phone with more volume



Martin Manders has a passion for upcycling vintage technology. He's well-known for using the Raspberry Pi to add 'smarts' to classic VCR and radio technology, but his latest project, the AlexaPhone, makes an old telephone ultra-smart with a connection to Amazon's Alexa voice search system.

Martin has stripped out a classic 1970s Trimphone and fitted a Raspberry Pi inside. "You lift the handset, speak your query, and the response from Alexa is read out via a built-in speaker," explains Martin.

Alexa provides users with information on the web via voice search, including weather, news,

and vital facts like 'how old is Graham Norton?' or 'why is the sky blue?'

"She has a fun side too," Martin tells us, "with a seemingly bottomless selection of dad jokes and preprogrammed responses to odd questions like 'would you like to build a snowman?'" Beyond the jokey façade, Alexa also sets timers and reminders, plays music, and reads audiobooks.

"I have a real weakness for retro design," says Martin, "especially telephones and televisions." The Trimphone was the height of technology in the 1970s, replacing the bell ring of classic phones with an electronic warbler. "I think I picked it up at a car boot sale in Brighton about 15 years ago," he



The finished project is a stylish 1970s Trimphone that calls Amazon's Alexa service

recalls. "It proved perfect for the AlexaPhone project, as the internal wiring has convenient modern ribbon cables for connection to the Raspberry Pi."

Martin used an old USB internet phone to connect the Trimphone's microphone to the Raspberry Pi. A cheap portable speaker is stripped down and fitted inside to play back the responses.

"After some digging around, I came across Sam Machin's excellent AlexaPi code on

enabled and headless. Getting all of the components to fit inside the phone body was a bit of a tight squeeze, but with some liberal plastic trimming it came together in the end."

The only thing Martin updated was the name of an MP3 file in the script. This was a straightforward change so that the AlexaPhone would sound its signature Trimphone ringtone on boot instead of Alexa's usual chirpy 'Hello!'.

"She has a fun side too, with a seemingly bottomless selection of dad jokes"

GitHub (magpi.cc/1U61O6r)," reveals Martin. "It offers Alexa integration for the Raspberry Pi with a physical button connected to the GPIO pins.

"The AlexaPhone started out as a quick distraction," he continues, "but was so much fun to build it just took over. "I got the AlexaPi software fully working on my Raspberry Pi 3 in the workshop, then repeated all the steps, removing cables as it gradually became wireless-

"I've found it accurate, the voice recognition is good, and even when I've stumbled over words, Alexa usually figures out what was said. I have it on my office desk and use it nearly every day, sometimes to get information, but often just asking questions out of curiosity to see whether Alexa will understand them. She's particularly good at maths as well, so the AlexaPhone comes in handy for double-checking the kids' homework answers."

BUILDING A RETRO VOICE ASSISTANT



>STEP-01

Hooking up a mic

A USB internet phone is hooked up to the Trimphone using a 3.5mm audio cable taped to the connections of the receiver. This acts as a digital microphone.



>STEP-02

Speaker

The AlexaPhone speaks its response after you hang up the receiver. A cheap toy USB speaker is stripped apart and wired up inside the AlexaPhone.



>STEP-03

Alexa calling

The body of AlexaPhone is Dremeled out to fit all the components inside. The end result is a neat Trimphone that calls Alexa when you pick up the handset.

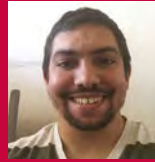

HARRY GONZALEZ-RIVERA

A system analyst living in Texas, Harry likes to take tech apart to figure out how it works in his spare time. magpi.cc/1tvSTTr

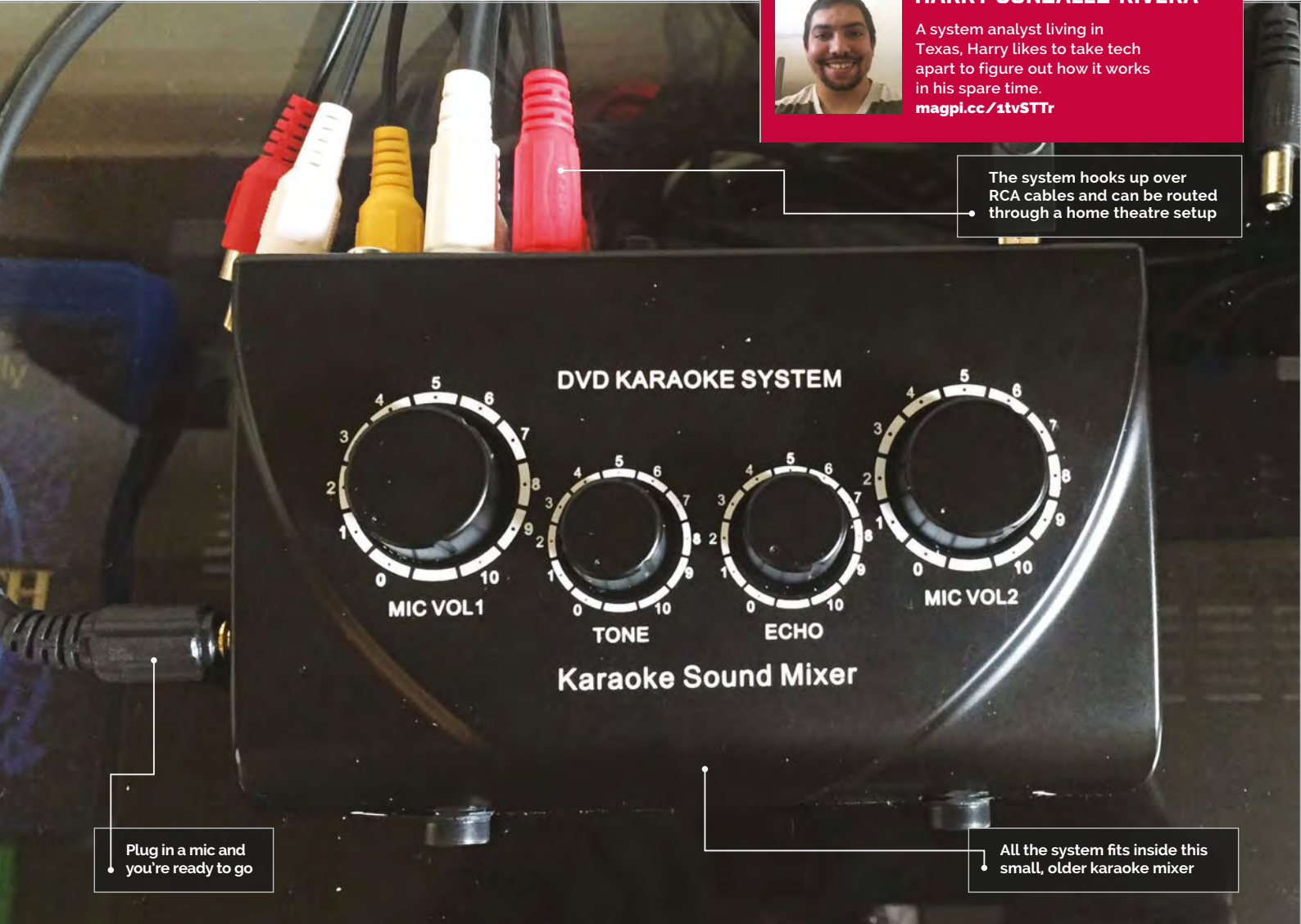

Plug in a mic and you're ready to go

The system hooks up over RCA cables and can be routed through a home theatre setup

All the system fits inside this small, older karaoke mixer

Quick Facts

- > The project uses bare-bones Raspbian
- > It took about a month's work at weekends
- > Harry's planning a second version powered by Pi 3
- > Karaoke is a Japanese portmanteau of kara okesutra, or empty orchestra
- > This is Harry's first project

PI ZERO KARAOKE BOX

Unimpressed with a consumer karaoke product, one Pi user made something far better with a Pi Zero

Certain members of *The MagPi* team like a good bit of karaoke. *Africa* by Toto, Disney music, the theme to *Mazinger Z* – it's all a bit of fun with the right people. Karaoke machines can be expensive, though, and the cheaper ones lack great functionality as well. Harry Gonzalez-Rivera came across this

problem when trying to buy a commercial karaoke machine. "About a year ago, I bought a consumer karaoke box that had USB and HDMI for about \$140," Harry tells us. "It looked awesome until I actually tried to use it: at first, the HDMI output created an audio delay and the output of the HDMI wasn't even 1080p.

It turned out to be a conversion from composite to HDMI. Also, the USB implementation of the device [for loading files] was poorly programmed." After getting a smart hub for home automation, Harry spent some time trying to get it to control his TV, and one of his friends joked that he should try

SING ALONG

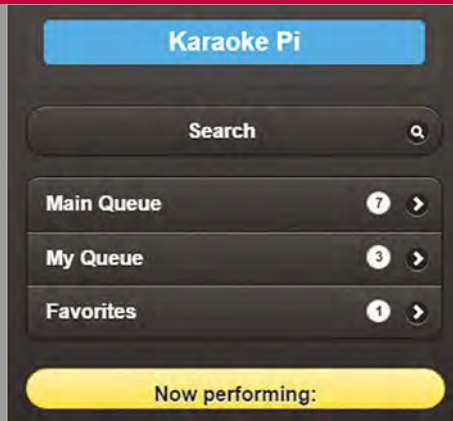

>STEP-01 Hook it up

The karaoke system uses RCA/composite for video and sound, so you'll need to find the old yellow, red, and white ports on the back of your telly.

>STEP-02 Boot it up

Once hooked up, you need to turn it on and wait for it to load everything up – after that, you can select a song via your browser.

>STEP-03 Belt it out

Once you've picked a song, sing. Sing to your heart's content. Put all your soul and emotion into that singular act. Then repeat.

to automate the karaoke machine as well. Harry ran with the joke: "I decided to do some research about using an Arduino or a Raspberry Pi to control the karaoke device, using an IR emitter to change songs, or look for a way to emulate a USB. I had an old Raspberry Pi Model B hanging around and remembered my uncle had a pretty cheap but cool karaoke mixer; I decided to do everything using the Pi and continued doing some research to see what I would need to make it work."

The mixer was quite small, so the system had to be built to an extreme size constraint, hence the

use of a Pi Zero. The Pi has a 128GB SD card, and is accompanied by a USB audio card and a USB WiFi adapter that are plugged into a small USB hub. All it needs is a mic, then you can hook it up to a TV and it's ready to go.

"Most of the research was done on the software side," Harry reveals. "There were a few projects that people had worked on, but none of them works perfectly on the Pi. While researching, I came to the conclusion that VLC worked perfectly with no resizing, so the project runs in the native CD-G resolution of 288x192. I also wanted to make it as bare-



Above This tiny box is unassuming, but contains all you need to rock out

bones as possible, so it took a lot of trial and error to run VLC with a pretty basic web back end that works perfectly."

The full code for Harry's karaoke box is available on GitHub, like all good projects ([magpi.cc/1UyX3iZ](https://github.com/magpi)), if you fancy giving it a go yourself. The biggest question about this project, though, is what is Harry's favourite song to do on karaoke?

"I mostly sing *La Flaca* by Jarabe de Palo (I'm from Puerto Rico), but in English I have to pick *Hotel California* by The Eagles."

That proves it, then: once you check into karaoke, you can never leave.



The basic system was tested before completion – not much was needed



VALENTIN PETRACHE

Valentin works as a full-time test engineer for web applications and is a part-time electronic hobbyist. He has created various electronic projects. magpi.cc/24yIWzx

An Arduino is hooked up to a DHT sensor to capture temperature readings

The device is housed safely inside a sealed plastic box with switches on the outside

The Raspberry Pi is used to maintain a database of temperature readings

Quick Facts

- Each hive has around 30,000 bees
- Valentin owns 30 hives in total
- It took about a month to build
- It measures the temperature outside the hive
- The battery lasts around three days

BEEKEEPING SERVER

Home-grown honey made with Raspberry Pi sounds tasty to us. Have a slice of this home-built beehive with smart scales and sensors



The Beehive Server lets Valentin know the ideal time to collect his honey

Bees are amazing! They build hives, waggle dance for each other, and make tasty honey, which we then steal and turn into Crunchie bars.

It's a good job bees make three times as much honey as they need, given how tasty it is. In summer months the bees are busy making honey, which they then use as food during the colder winter months.

Beekeepers aim to snaffle the extra honey at just the right time. One smart *MagPi* reader, Valentin Petrache, got rid of the guesswork and built a smarter beehive. The Beekeeping Server measures

the weight and temperature of a hive. Valentin then uses the data to figure out the exact time to harvest his honey.

"When I first thought of the idea," says Valentin, "I made a checklist of important information on beekeeping, and how to harvest as much honey as possible.

"I measure the outside temperature and humidity," he tells us. "It's important to know when the bees are active, and to know the hive's weight.

"In beekeeping, it's important to keep your hives close to a lawn of flowers where bees extract

pollen and produce honey. If the flowers don't have enough pollen, the bees start eating the honey from the hive. Therefore, you have to move the hives to a better area. So I thought, "What a great idea to have a weight scale under a hive."

The Beekeeping Server merges different devices and sensors. The project contains a Raspberry Pi, Arduino board, DHT23 sensor, HX-711 scale amplifier board, load scale (rated at 300kg), small LCD, WiFi dongle, and lithium polymer battery.

"The Arduino board is the core of the project," explains Valentin. "It reads the temperature, humidity and weight, and prints it in a human-friendly format. The HX711 amplifier sensor reads raw data from the load scale and sends it to Arduino in kilograms. The DHT sensor reads outdoor temperature and humidity, and the LCD [displays] weight, temperature, and humidity."

"The Raspberry Pi has the role of the server for wireless communication," he continues. An Apache server and SQL database are set up in Raspbian. The Raspberry Pi accesses the

data from the Arduino and hosts a webpage displaying the results. Alternatively, the small LCD on the beehive provides data on-site.

"It took about a month to build," says Valentin, "and of course there were problems." From library issues all the way to frying a board, Valentin has had his work cut out.

"At first, I had problems with getting a reading from the HX711 sensor. My scale had different colour codes for the four wires it has, and the HX711 was getting no data. Currently, I have problems with the weight

I get. The scale is very sensitive to temperature variation. I'm currently trying to resolve that problem by creating a thermal barrier between the sensor and outside temperature."

Despite the gremlins, the Beekeeping Server is in constant use. Valentin is ironing out the issues and looking to add a solar panel soon (the battery needs changing every three days).

"It's fun building one," he tells us. "The process of creating something, and the information you learn during the build process, it's all very rewarding."

Above The temperature and weight of the hive are accessed remotely, letting the owner know when the honey is ready to be collected

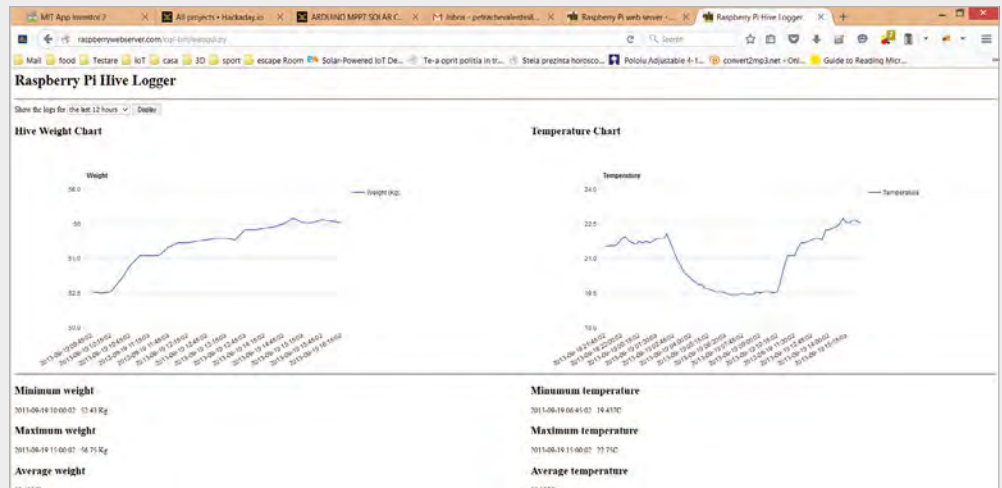

INSIDE THE HIVE

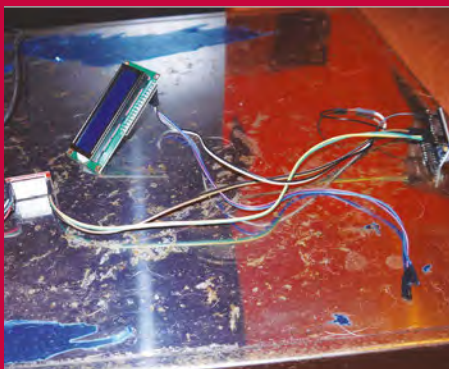

>STEP-01

Arduino and DHT sensor

A DHT (digital humidity and temperature) sensor is connected to the Arduino on port 10. An LCD is hooked to the Arduino, so Valentin can check the readings locally at the beehive.

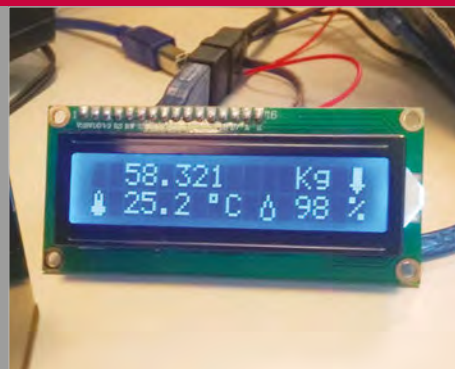

>STEP-02

Box and buttons

A plastic tub is used as an enclosure to protect the parts from the bees. A button is connected to pin 12. Pressing it activates the backlight so the LCD can be read in low light conditions.



>STEP-03

Bee safe

The Raspberry Pi and Arduino devices are placed inside the sealed box, with a switch used to turn it on and off. This unit is then connected to a weight scale, mounted at the bottom of the beehive.



MATTHEW ZIPKIN

A lifelong programmer, Matthew is a professional audio engineer working on TV, films, and music. youtu.be/78u8EQtIXMY



Powered by Pi (and other things) to connect to the Bitcoin network

Visualise the current state of the block chain with this display

Interact with the monitor clock and even use it as a Bitcoin piggy bank

BITCOIN BLOCK CLOCK

Visualise a Bitcoin node with a great light display that tells you how well the current block is going in your block chain

Quick Facts

- > The build took about four months
- > A full list of components can be found here: magpi.cc/1PngLXo
- > The enclosure build was fairly new ground for Matthew, but turned out well
- > Matthew chose the Pi due to the strength of the community
- > Matthew is currently building a second, better version

If you work or pay attention to the technology industry, you'll know how ubiquitous Bitcoin is. The digital currency is big in the tech world, and considering how much Bitcoin is currently worth, it can be very advantageous to help mine some of it – it's basically free money! Well, minus the expense of the electricity required to help with the mining. Raspberry Pis are quite popular for Bitcoin uses, but Matthew Zipkin has found a fairly novel way of connecting his Pi to Bitcoin.

“The Bitcoin Block Clock is a Bitcoin full node connected to a 32x32 RGB LED grid, which visualises certain network properties in a fun, colourful clock-like display,” Matthew explains. “So that’s two things: a Bitcoin full node is a computer that runs the Bitcoin software. It connects to 12 peers on the network who also run the same software, and together as part of the ~7,000-node Bitcoin network establish the global consensus on the block chain, the ledger of all Bitcoin transactions. That software

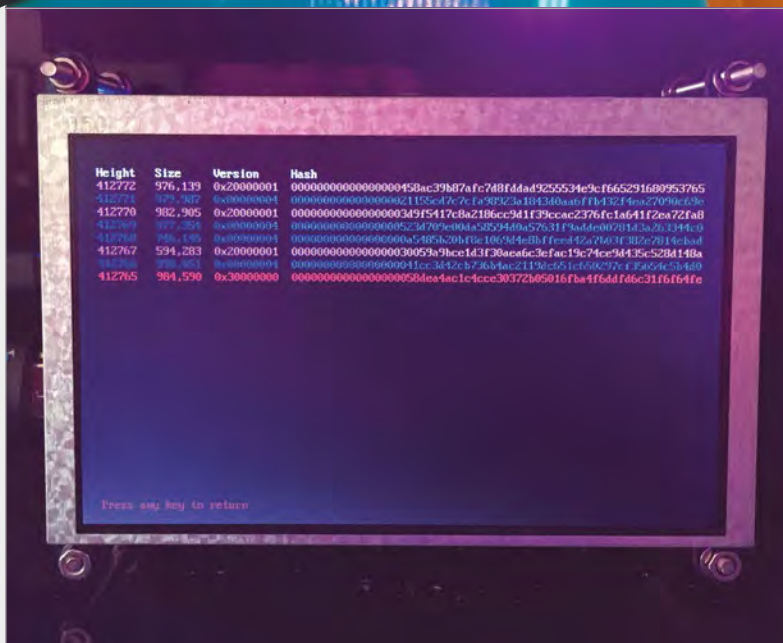

Left More information is provided on the screen below the display

HOW TO VISUALISE BITCOIN



>STEP-01

Start it up

Plugging in the system is only the first step, as you need to start the specific script as well to make sure everything is running.

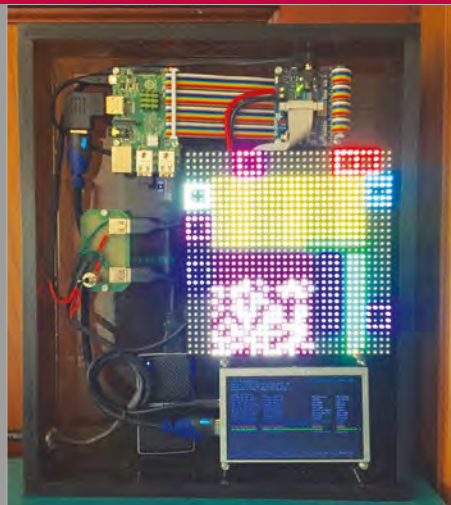

>STEP-02

Clock display

You can just sit and watch the Bitcoin interactions, powered by a specific API and code that translates the data in real time for the display.

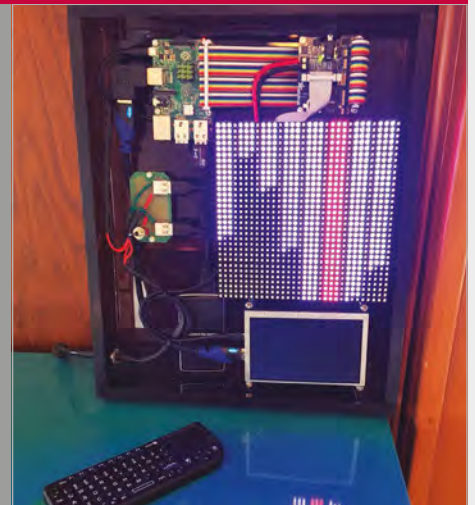

>STEP-03

Different displays

You can also change the displays and interact with the clock using a wireless keyboard. You can then deposit and withdraw money from it.

can also send and receive Bitcoin transactions, giving my project a ‘piggy bank’ functionality. You can send money to the clock!”

The LED grid lights up and shows a lot of data for the user, including current block progress, how difficult it is to mine Bitcoins, and how much you can mine. It may look a little complicated, but to those in the know it offers a lot of useful info.

“There are a few companies that sell compact Bitcoin full nodes to users and hobbyists,” Matthew tells us as he explains why he made it. “But they’re boring! They don’t even have a screen. You just plug it into the wall like an air freshener and let it do its thing. You can SSH into them and do technical things, but they really provide very little utility to the user. There was one company that used to make them with a screen that at least showed some network statistics, and I wanted one, but they went out of business! So I decided to make my own.”

The final product looks great and, according to Matthew, works

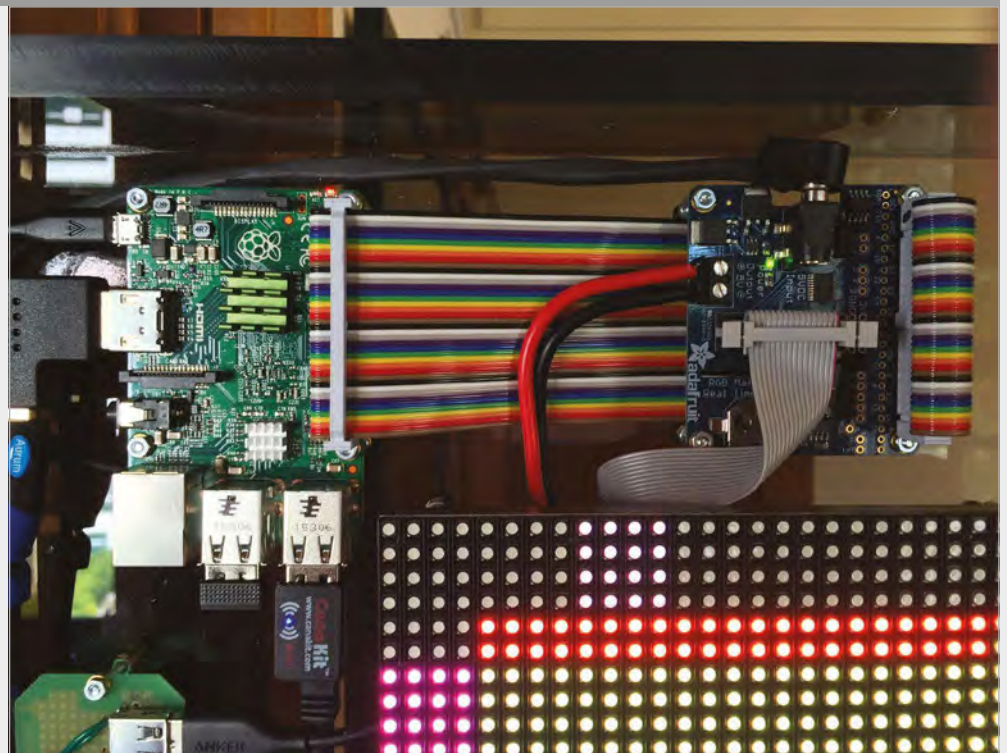

well: “It’s been running non-stop ever since I finished it. The SSD was a huge help. Lots of compact full nodes just use a USB flash drive, and that works OK just for the Bitcoin stuff. But the other functions I wanted my clock to do were so slow, and I discovered the

bottleneck was the flash drive. It looks awesome and everyone who comes into my living room is mesmerised by it. It looks like some crazy alien clock! You don’t need to know anything about Bitcoin or computers to appreciate that it’s cool.”

Above The whole system is open for all to see: no tricks here



The **MagPi** ESSENTIALS

LEARN | CODE | MAKE

AVAILABLE NOW:

- > CONQUER THE COMMAND LINE
- > EXPERIMENT WITH SENSE HAT
- > MAKE GAMES WITH PYTHON
- > CODE MUSIC WITH SONIC PI



The **MagPi**
ESSENTIALS

From the makers of the
official Raspberry Pi magazine

OUT NOW IN PRINT
ONLY £3.99
from
raspberrypi.org/magpi



GET THEM
DIGITALLY:



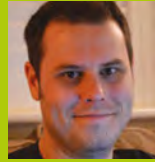

ROB ZWETSLOOT

Tinkerer, sometime maker, other-times cosplayer, and all-the-time features editor of *The MagPi*.
magpi.cc / @TheMagPi1



You just need two devices to get this style of automation started

With built-in Bluetooth support, the Pi 3 is perfect for this kind of automation

This can be achieved with nothing more than a phone as a tag

CREATE A RASPBERRY PI 3 BLUETOOTH TAG

You'll Need

- > PyBluez module magpi.cc/1VOuGCy
- > Wakeonlan Python module magpi.cc/1VOvpDF
- > Compatible PC
- > Bluetooth dongle (optional, only if you don't have a Pi 3)

Have a Raspberry Pi 3 switch on your computer when you get home from work, by looking out for a Bluetooth device

Affordable automation is just one of the many popular projects for the Raspberry Pi since its release. We can easily see why: it's small, easily programmable, and has a huge community backing it with software and support. Now that the Pi 3 has built-in Bluetooth, it's even easier to create events to help control your house better. We're going

Below Small tags like this can be used as well, although you might need to do a little bit of hacking on them



to show off a simple project by creating a Python script that sends a Wake-on-LAN (WoL) magic packet to your PC when it detects a specific mobile phone's Bluetooth signal.

>STEP-01 Prepare your Raspberry Pi

We'll need several extra pieces of software added to the Raspberry Pi to get our little system working. Both connecting to Bluetooth and sending a Wake-on-LAN signal require extra modules for Python. First, grab pip – the Python package installer – so we can add them:

```
sudo apt-get install python-pip
```

Once that's done, you can install the PyBluez and wakeonlan modules with pip, using the following two commands:

```
sudo pip install pybluez
sudo pip install wakeonlan
```

bluetooth_tag.py

```
#!/usr/bin/env python
```

```
import time
import bluetooth
from wakeonlan import

phone = "ff:ff:ff:ff:ff:ff"

def search():
    devices = bluetooth.discover_devices(duration = 5, lookup_names = True)
    return devices

while True:
    results = search()

    for addr, name in results:
        if addr == phone:
            wol.send_magic_packet('ff:ff:ff:ff:ff:ff')

    time.sleep(20)
```

Language

>PYTHON 2

DOWNLOAD:
[magpi.cc/
BluetoothTag](http://magpi.cc/BluetoothTag)



>STEP-02

Get an address

We're going to program the Pi to look out for a specific Bluetooth device, using the latter's MAC address for complete accuracy. While creating this tutorial, we used an Android phone; for any Android device with Bluetooth capabilities, you just need to go to 'About phone' and then 'Settings' to find the MAC address for the Bluetooth interface. You'll need to look up information specific to your type of phone or Bluetooth device on how to find its MAC address. Either way, make a note of this address.

>STEP-03

Wake up your PC

Wake-on-LAN is built into many PCs. The wired network interface is receptive to the 'magic packet' that tells it to turn on. However, the WoL packet needs a MAC address to look for, rather than an IP address, as the PC is off. Boot into the BIOS of your PC; directions to do this should be on the splash screen when you turn your PC on. Enable Wake-on-LAN if it's available, then boot into your operating system and look up the details on your wired network to find the MAC address.

>STEP-04

Get coding

We're just about ready to get this all working; all we need now is the code. Copy it from the listing or download it from magpi.cc/BluetoothTag. You'll need to edit it a bit on the Raspberry Pi, replacing the MAC address for the phone with the device that activates the Wake-on-LAN. You'll also need to edit the MAC

address on the line `wol.send_magic_packet` to be that of your PC. Press **F5** to give it a test; you may need to play about with your device's Bluetooth settings for it to work properly.

>STEP-05

Run at boot

It won't be easy to run the script in IDLE all the time for this, so it's best to have the script executed at boot time. Assuming this isn't a Raspberry Pi you'll be using for much desktop work, you should first set it to boot to command line and also to automatically log in. Once that's done, open up your user profile with:

```
sudo nano /etc/profile
```

...and add this line to the end of the file:

```
sudo python /home/py/bluetooth_tag.py &
```

Save and exit. Rebooting will start the script automatically.

>STEP-06

Future edits

The script is easily upgradeable and expandable. You could have it look for multiple Bluetooth devices, you could change the timing (how long it checks and the time between checks), you can have it send a magic packet to multiple systems, etc. That's just the beginning as well: with such triggers, you can set off many other automation tasks that can be controlled by Python.

Above This is where you can find the MAC address on an Android phone, but it will differ on other devices



LUCY ROGERS

Tamer of robot dinosaurs, hacker of the IoT, author. Translates science into plain English. Positively affecting the lives of a billion people.
lucyrogers.com / @DrLucyRogers

MAKE A DINOSAUR REACT TO YOUR EMAIL

Hack a toy dinosaur with Node-RED to provide email notifications

You'll Need

- > Connex Action Dinosaur Electronics Kit: magpi.cc/1ScJbZX
- > LED & 1kΩ and 330Ω resistors
- > NPN Darlington pair transistor
- > Diode 1N4001
- > Breadboard and cables

Want to let the kids know it's time for dinner by waking a toy in their bedroom? Or have a fun alert on your desk when you receive an email? This project takes you step by step through the process of hacking a cheap toy and using a Raspberry Pi, Node-RED drag-and-drop visual programming, and simple electronics to make a dinosaur move on demand. The electronic circuit used in this project can also be used to control larger motors, relays, or high power LEDs. First step, toy dinosaurs – next step, email control of all your home automation devices?

>STEP-01

Install Node-RED on your Pi

Before connecting anything to the GPIO pins of your Pi, we'll draw the code. If you have the latest version of Raspbian Jessie, Node-RED comes installed in your Programming folder. If not, you can install it via a terminal (see magpi.cc/28PJz20). You also need the Firefox browser. Connect your Pi to the internet, open Node-RED (**Menu>Programming>Node-RED**), and paste the address at the top of the Node-RED window into Firefox. This address should be something like **http://192.168.X.XXX :1880**. You should now see the Node-RED flow page. If you find everything is sluggish, you may like to access that address from another computer's browser.

>STEP-02

Intro to Node-RED

If you haven't used Node-RED before, start by making an 'inject-debug' flow. Drag an **inject** node from the Input section of the left menu into the middle pane. Its name should change to **timestamp**. Repeat with a green **debug** node from the Output menu. Join the two by clicking one of the grey pimples and drag it to the pimple on the other node. Click the big red 'deploy' button at the top-left. Activate the **inject** node by clicking the square to the left of the word **timestamp**. The resulting message (payload) appears in the debug tab.

>STEP-03

Draw the flow

Drag the **email** node with the connector on the right into the work area. Double-click it and enter your email credentials. Connect a **debug** to the **email** node, to check what messages are arriving. The message contains the email text and who it's from. Drag in a **switch** node and double-click to make some changes. For Rule1, change the '==' to 'Contains' and type

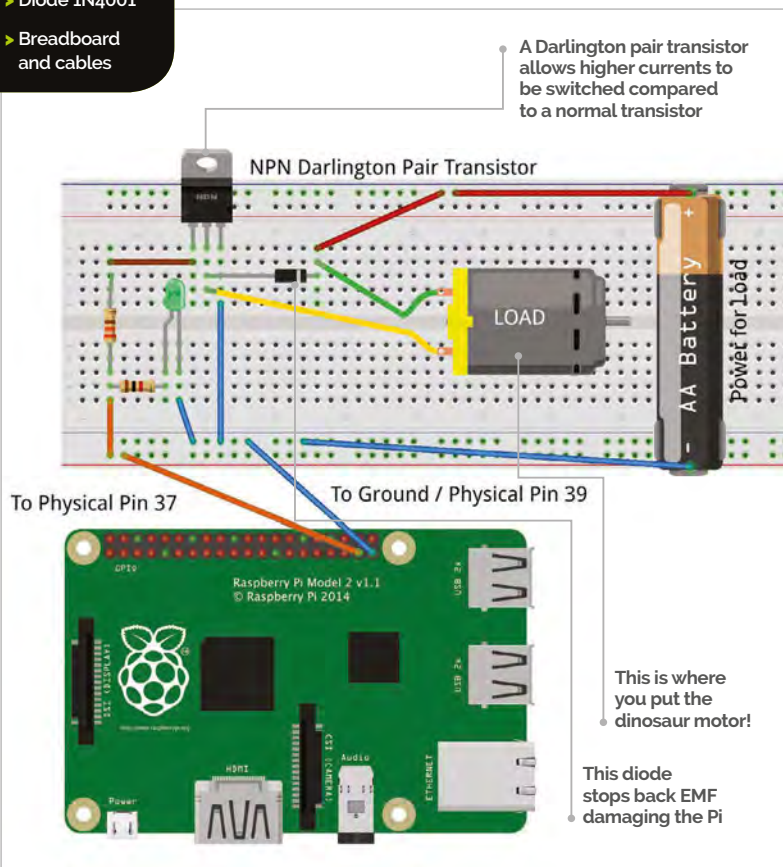

Set your dinosaur free! There are already a few dinos in the wild – tamed by @andysc, @neilcford, @fortoffee and @andypiper

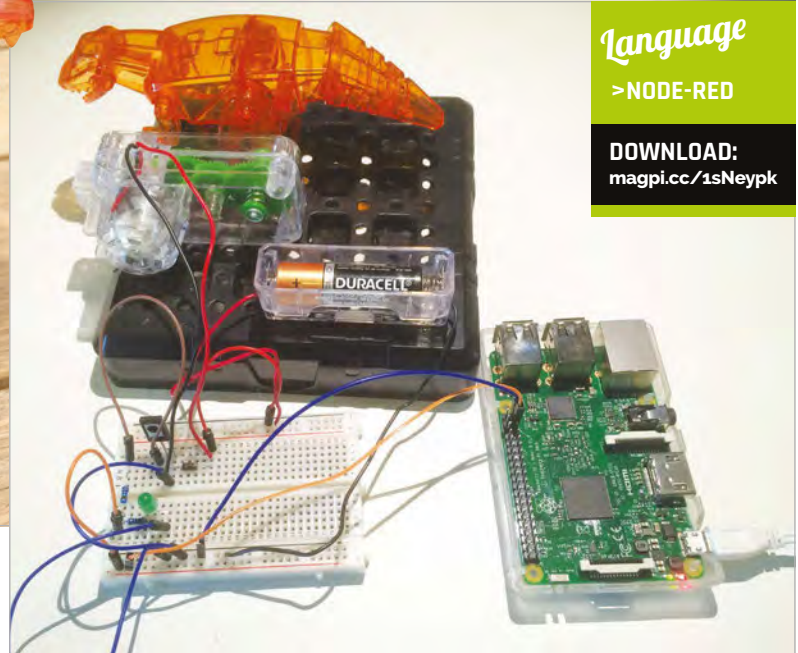

Language

> NODE-RED

DOWNLOAD: magpi.cc/1sNeypk

'Dinner' (without quotes) into the text string box. Any email that contains the word 'Dinner' will output to the first (top) output node. Click '+ rule' near the bottom, and change '==' to 'otherwise'. All other messages will go to the second (bottom) output node.

>STEP-04

Turn the motor on and off

The message must just be '1' or '0' to turn the motor on or off. To change it from the text, add a **change** node and change the message to a 1. Connect an **inject** node to the input of the **change** node. This will allow you to text the flow without sending an email. Add a **delay** node and another **change** node, and change the message to zero, otherwise the dino won't stop. Connect both the first **change** node and the **delay** node to a **GPIO out** node (connector on left). Set the pin to physical pin 37. Deploy the flow.

>STEP-05

Make the circuit and dinosaur

Connect the circuit as shown in the diagram. Turn the Pi off before connecting anything to the GPIO pins. As this motor is low current, we could use a transistor rather than a Darlington pair. However, the latter

allows higher currents to be switched, and so this circuit can be used for other projects – but never mains or AC. Assemble the dinosaur kit. Make sure the dino can nod freely. The kit's battery holder and motor connect straight to the breadboard. You don't need the switch. On the Raspberry Pi, use the ground on physical pin 39 and GPIO pin 37.

Above
The complete project. Now you just need to email 'Dinner' to get everyone's attention

>STEP-06

Make dino nod and roar

Turn the Pi back on and open Node-RED again. Click the **inject** node and the dinosaur should nod. Now send an email with 'Dinner' in the message (not in the subject). The dino should nod again! To get your dino to speak, attach a speaker to the Raspberry Pi, then add an **exec** node into the flow. You may need to install MPlayer onto the Pi (use **sudo apt-get install mplayer** from a terminal). Make sure your 'roar' MP3 file is on the Pi. Double-click the **exec** node and type in the command box: **mplayer /home/pi/.node-red/roar.mp3**

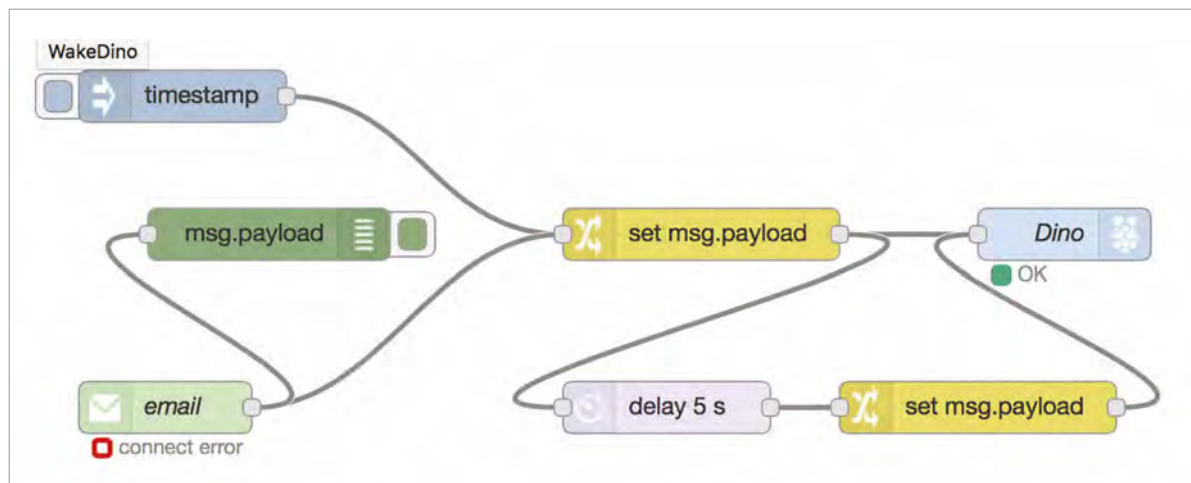

Left This Node-RED flow will trigger if any email is received. The delay node stops the dino after five seconds

PYTHON

If you want to do this using Python, see @ForToffee's blog (magpi.cc/1sNeTZj) or Chris Robbins' (magpi.cc/1sNeMNI).



THE HAYLER-GOODALLS

Ozzy, Jasper, and Richard are mentors at CoderDojo Ham and gave a talk at the Raspberry Pi birthday party about their Astro Pi adventures.

richardhayler.blogspot.co.uk
[@rdhayler](https://twitter.com/rdhayler) / coderdojoham.org

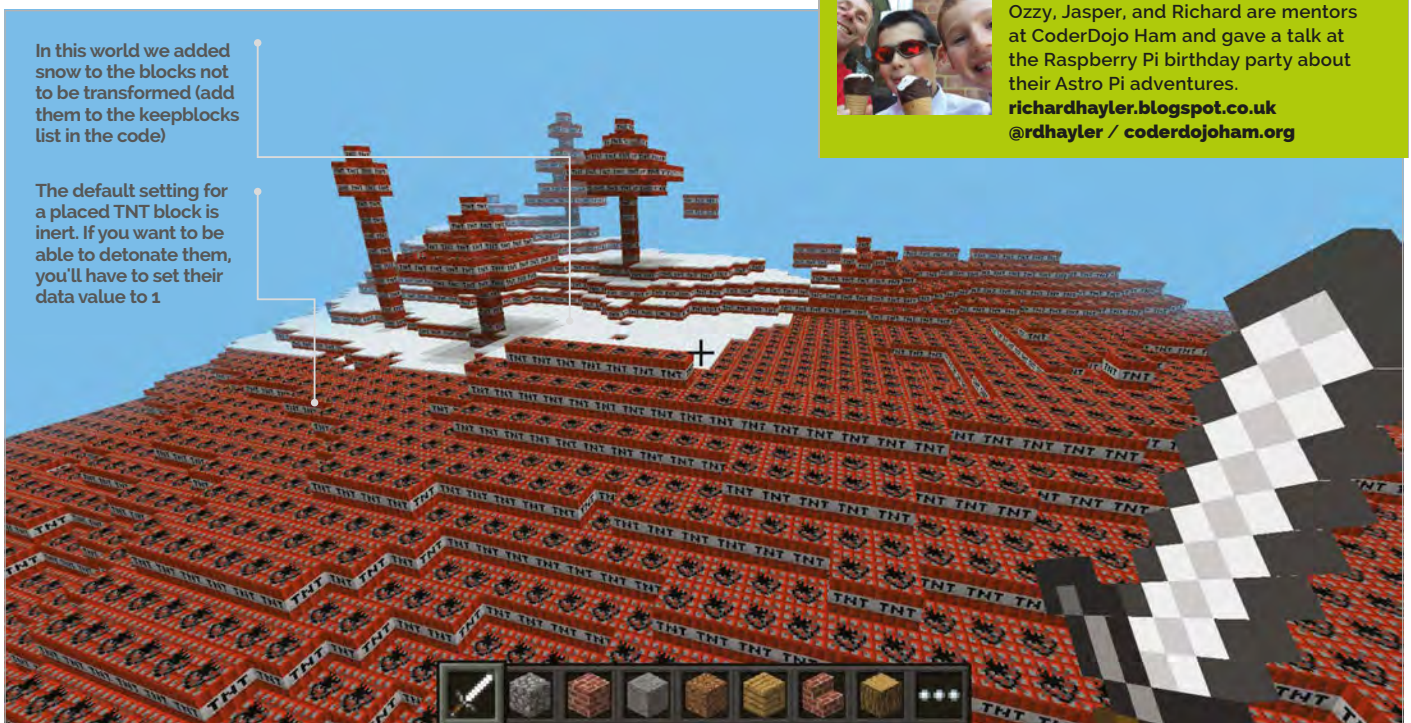

In this world we added snow to the blocks not to be transformed (add them to the keepblocks list in the code)

The default setting for a placed TNT block is inert. If you want to be able to detonate them, you'll have to set their data value to 1

You'll Need

- > Initial State account initialstate.com
- > ISStreamer and Python 3 library
- > psutil Python 3 library

TERRAFORMING MINECRAFT

Everyone has their favourite Minecraft block. What if you could have an entire world made out of them?

Imagine fields of gold, fit for King Midas or the dragon Smaug. Or how about a frozen landscape where everything has been turned to ice? Just think what you could do in a world where everything is primed TNT.

Using Python, we can start a terraforming process to remake a *Minecraft* world to your specifications. Even on a Pi 3, this will not be a quick process: depending on how complex your landscape is, and how much you want to transform, it may take several days. So we'll monitor our progress by uploading data to an Initial State dashboard so that we can keep track of things remotely. If you just want to do the terraforming, there's another version of the code without the Initial State functionality in the same GitHub repository ([terraforming_no_is.py](https://github.com/magpi/terraforming_no_is.py)).

>STEP-01
Generate your world

Before you start coding, you need to create your *Minecraft Pi Edition* world and select the block type with which you want to fill your world. This can be

any block of your choice, but it has to be a solid block (not ladders or torches). Manipulating the *Minecraft* ecosystem can be tricky. For example, if you try to turn water directly to lava, you'll probably end up with lakes of obsidian, so you might need an intermediate step: turn all the water to something inert (like wool), then transform it to lava. There may also be some blocks you want to keep – snow or water, for example.

>STEP-02
Get the code

Make sure your Pi is up to date and, if you want to create a remote monitoring dashboard on Initial State, download and install its data streaming library:

```
sudo pip3 install ISStreamer psutil
```

Then download the `is_terraforming.py` code (magpi.cc/234A3hY). Note that you'll need to change some of the values to suit your *Minecraft* environment and to include your Initial State account details.



Language

>PYTHON 3

DOWNLOAD:
magpi.cc/234A3hY

>STEP-03
Tune the code

Terraforming can take a long time – we’re talking days rather than minutes. However, we can tune our code to speed things up. Explore your world and find the tallest mountain range and deepest valley. Make a note of the height (the third value displayed in the top-left corner of the screen). You can then plug these values into the code.

We have set the default terraforming height range from -3 to 35 on the y axis, but you can make this bigger (this will take longer) or shorter (this will take less time), depending on the size of the geological features in your world.

>STEP-04
Set the speed for the power of your Pi

This code should work on any type of Pi, but older, less powerful models may struggle if you terraform at full speed. If *Minecraft* can’t keep up with all the changes it’s being asked to make to the landscape, it may hang. Therefore, it’s a good idea to pause after a certain number of blocks, to allow *Minecraft* to catch up. On a Pi 3, you can comfortably transform 500+ blocks before the need for a pause, but for a Model B you may need to deal with 50 blocks at a time. You’ll probably want to run a few experiments to find the optimum configuration for your setup.

>STEP-05
Register for an Initial State account

Initial State allows you to upload live data and plot interesting charts and graphs. A free account lets you stream 25,000 events a month and examine the last 24 hours’ worth of data in any bucket. Once you

have registered for an account, click on the ‘create HTTPS bucket’ button (the plus symbol) and give it a suitable name. Then check ‘Configure Endpoint Keys’ and copy the Bucket Key and Access Key into your version of the code.

Above You can create some very strange-looking worlds, like this one where everything on the surface is made of glass

>STEP-06
Start terraforming!

If you’re using a free account, edit the code and set the **Free_account** variable to True. This will throttle the amount of data sent to Initial State and allow you to record the whole process without exceeding the data cap.

Start your code running and check the console for any errors. You can fly to the corner of your world and should soon be able to see the changes taking place. Once the first data reaches Initial State, you can create a cool dashboard: use the Tiles interface and play around with the different types available.

Below Initial State has a range of graph types to make your terraforming data look informative and cool at the same time





DAN ALDRED

A Raspberry Pi Certified Educator and a lead schoolteacher for CAS. He's passionate about creating projects and uses projects like this to engage the students that he teaches.

tecoed.co.uk / @dan_aldred

The egg, a yellow LED, falls from a random starting point at the top of the Sense HAT

The positions of the LEDs are numbered and use an x and y axis. However, this starts from the top-left of the matrix

Tilt the Sense HAT left or right to move the basket to where you think the egg will land – can you catch it?

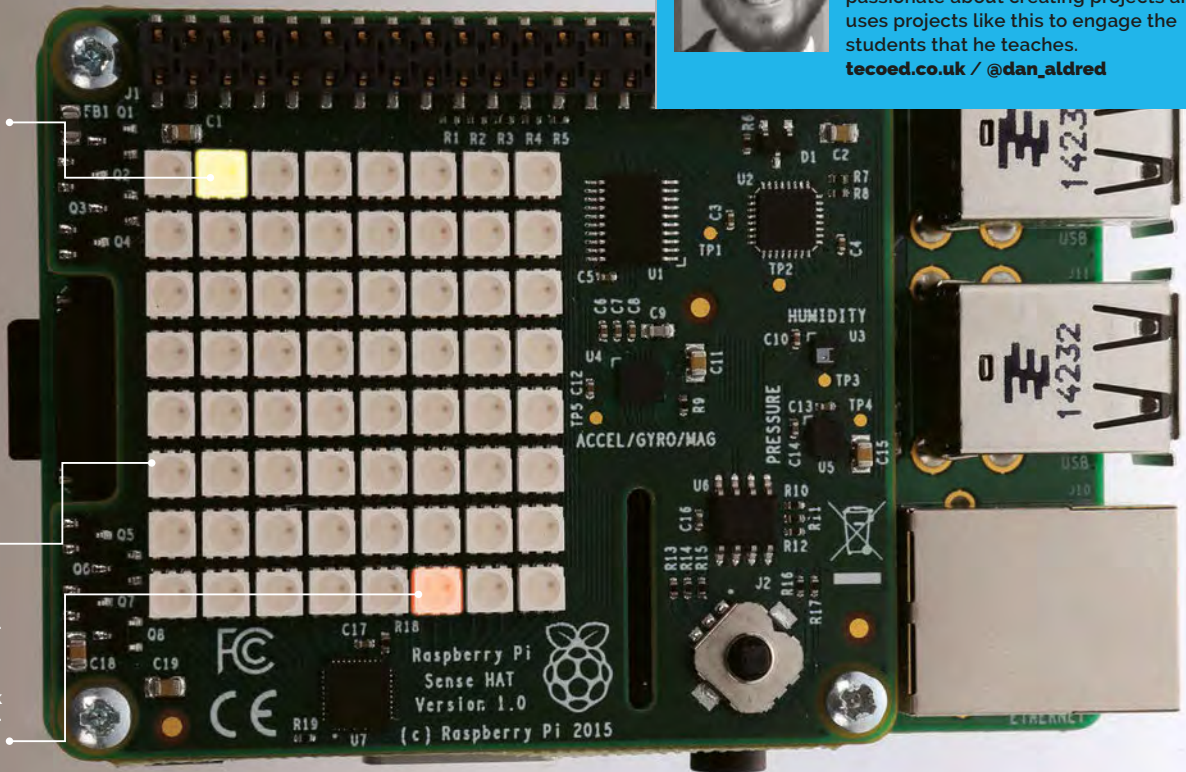

MAKE A MOTION-CONTROLLED EGG DROP GAME

You'll Need

- Raspberry Pi
- Sense HAT
- magpi.cc/1TGGUt5

Can you catch the eggs as they drop from the top of the Sense HAT?

Some of the most basic and repetitive games can be the most fun. Consider *Flappy Bird*, noughts and crosses, or even catch. With this in mind, a simple drop-and-catch game makes excellent use of the Sense HAT. Code a yellow LED to drop each second, and a basket on the bottom row of LEDs. Use code to record the accelerometer reading and utilise this so that when you tilt your Sense HAT left or right, you can move the basket to catch the egg. Catch it and you play again, but if you miss one, then it breaks and it's game over.

Getting set up

Ensuring that your Raspberry Pi is turned off, attach your Sense HAT to the GPIO pins. Use the supports and screws to secure the HAT into position. Plug in the power and boot up your Pi. The Sense HAT Python library is included with the current OS image and requires no installation. Either load your preferred Python editor and type up the code, or download it to

your Raspberry Pi, saving it into your home folder. To run the code, press **F5**; after a short introduction screen and a countdown, the game will begin. If you open the code in a text editor, you can customise some features of the program such as the messages, the colours used, and the splash screen.

To edit or use your own message, find the code line which begins **sense.show_message** – for example, on line 32. Change the text within the speech marks and add your own message. Editing the colour of the message is possible and achieved by changing the red, green, and blue (RGB) values. The maximum value for each is 255, which is the full amount of colour. These can be combined to create a wide range of colours. For example, the colour blue is **[0, 0, 255]**.

Like the text, you can also change the colour of the egg or basket by editing the RGB values within the square brackets. These are set using the code **sense.set_pixel**, found on line 46. You could change the values to **[0, 255, 0]** to create a pea drop game!

Language
>PYTHONDOWNLOAD:
magpi.cc/1teCX7Y

Editing and using images

When the game begins, an image of a chicken is displayed. This is loaded from a file called **chick.png**, which is stored in the same folder as your egg drop program file. You can create your own images to display throughout the game and use the code `sense.load_image("chick.png")` on line 34, replacing the file name 'chick.png' with the name of your file. An effective tool to create an image is **RPi 8x8 Grid Draw**, a superb on-screen program that enables you to manipulate the LEDs in real time. You can change the colours, rotate them, and then export the image as code or as an 8x8 PNG file. First, we need to install the 'Python PNG library' – open a terminal window and type: `sudo pip3 install pypng`. After this has finished installing, type:

```
git clone https://github.com/jrobinson-uk/
RPI_8x8GridDraw
```

Once the installation has completed, move to its folder by typing `cd RPI_8x8GridDraw`, then type `python3 sense_grid.py` to run the application.

The Grid Editor enables you to select from a range of colours displayed down the right-hand side of the window. Simply choose a colour, then click the location of the LED on the grid and select 'Play on LEDs' to display the colour on the Sense HAT LED matrix. Clear the LEDs using the 'Clear Grid' button then start over. Finally, when exporting the image, you can either save as a PNG file or you can export the layout as code and import that into your program.

Remember that the image size is limited to 8x8 pixels. If you're looking for inspiration, check out Johan Viet who has some excellent examples of 8x8-pixel art (magpi.cc/1SrQGDm).

Dropping the egg

Both the basket and egg mechanics are similar, except that the basket only moves left and right along the x axis. This means that the y axis value stays static.



To simulate the egg dropping, the first LED is set in position and coloured yellow (line 46).

The `egg_x` is the value the LED's horizontal position at the top of the matrix; remember, this is selected at random at the start of each drop. The `egg_y` value refers to the LED's vertical position. The LED is then coloured black, giving the impression that it's no longer there (line 63). The `egg_y` value is increased by one, which moves to the LED down one place (line 64). Then that LED is coloured yellow, giving the appearance that the egg has dropped down one space (line 65).

The basket is set by turning on one LED (line 47); this creates a nice brownish colour. Since the basket doesn't move up, the y value position is set to 7. The orientation of the Sense HAT is taken using `pitch = sense.get_orientation()['pitch']` on line 55. This value is fed into a function called `basket_move` (line 18), which calculates the new position of the LED in relation to the amount of tilt. Again, the LED is set to black so it appears that the basket has left its current position (line 62). Lastly, the new position is set using `sense.set_pixel(basket_x, 7, [139, 69, 19])`, where `basket_x` is the new value of the position of the LED along the bottom of the matrix.

Above Once the egg is on the bottom line of LEDs, its position is compared with the position of the basket

Below To make the game more interesting, the egg is dropped from a random position each time a new egg falls

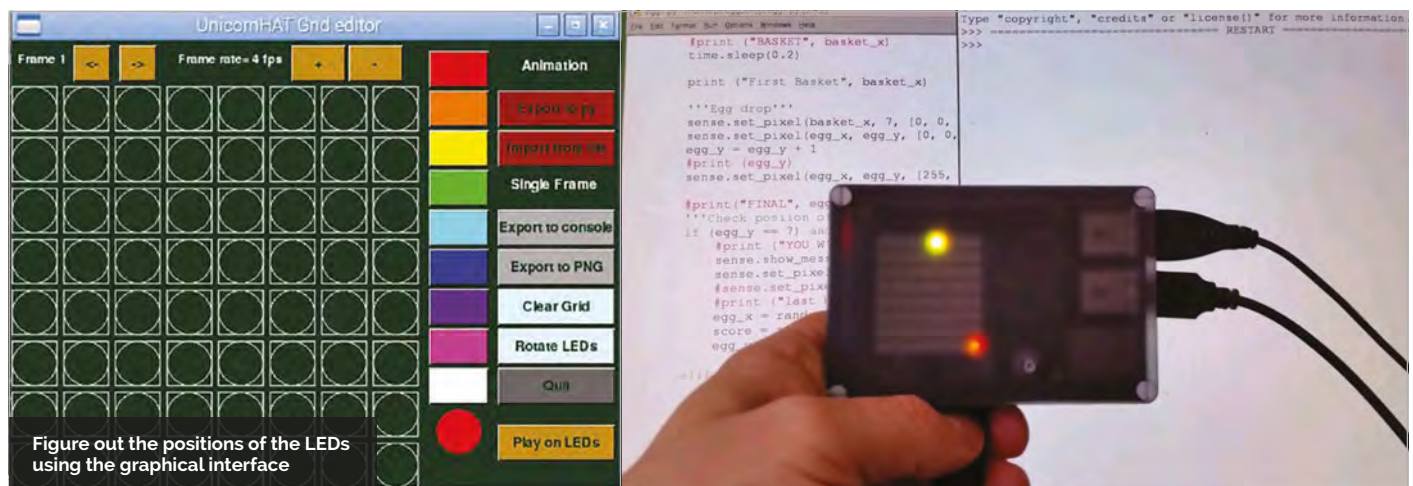

Figure out the positions of the LEDs using the graphical interface



Sonic Pi PART 11



SAM AARON

Sam is the creator of Sonic Pi. By day he's a research associate at the University of Cambridge Computer Laboratory; by night he writes code for people to dance to. sonic-pi.net

CODE A PROBABILISTIC SEQUENCER

After a brief break while touring, **Sam Aaron** is back to continue his amazing Sonic Pi series

You'll Need

- > Raspberry Pi running Raspbian
- > Sonic Pi v2.7*
- > Speakers or headphones with a 3.5mm jack
- > Update Sonic Pi: `sudo apt-get update && sudo apt-get install sonic-pi`

In a previous episode of this Sonic Pi series, we explored the power of randomisation to introduce variety, surprise, and change into our live-coded tracks and performances. For example, we randomly picked notes from a scale to create never-ending melodies. Today we're going to learn a new technique which uses randomisation for rhythm – probabilistic beats!

Probability

Before we can start making new beats and synth rhythms, we need to take a quick dive into the basics of probability. This might sound daunting, but really it's just as simple as rolling a dice! When you take a regular six-sided board game dice and roll it, what's actually happening? Well, firstly you'll roll a 1, 2, 3, 4, 5 or 6, with exactly the same chance of getting any of the numbers. In fact, given that it's a six-sided dice, on average (if you roll lots and lots of times) you'll throw a 1 every six throws. This means you have a 1 in 6 chance of throwing a 1. We can emulate dice rolls in Sonic Pi with the `dice` function. Let's roll one eight times:

```
8.times do
  puts dice
  sleep 1
end
```

Notice how the log prints values between 1 and 6, just as if we'd rolled a real dice ourselves.

Random beats

Now imagine you had a drum and before you hit it you rolled the dice – if you got a 1, you hit the drum (otherwise

you didn't). You now have a probabilistic drum machine working with a probability of 1/6! Let's hear it:

```
live_loop :random_beat do
  sample :drum_snare_hard if dice == 1
  sleep 0.125
end
```

Let's quickly go over each line to make sure everything is clear. First, we create a new `live_loop` called `:random_beat`, which will continually repeat the two lines between `do` and `end`. The first of these lines is a call to `sample`, which will play a pre-recorded sound (the `:drum_snare_hard` sound in this case). However, this line has a special conditional `if` ending. This means that the line will only be executed if the statement on the right-hand side of the `if` is `true`. The statement in this case is `dice == 1`. This calls our `dice` function which, as we have seen, returns a value between 1 and 6. We then use the equality operator `==` to check to see if this value is `1`. If it is `1`, then the statement resolves to `true` and our snare drum sounds; if it isn't `1`, then the statement resolves to `false` and the snare is skipped. The second line simply waits for `0.125` seconds before rolling the dice again.

Changing probabilities

Those of you who have played role-playing games will be familiar with lots of strangely shaped dice with different ranges. For example, there is the tetrahedron dice which has four sides, and even a 20-sided dice in the shape of an icosahedron. The number of sides on the dice changes the chance, or probability, of rolling a 1. The fewer sides, the more likely you are to roll a 1; the more sides, the less



Image by Chris Yarzab. magpi.cc/28ixWwp (CC BY 2.0)

likely. For example, with a four-sided dice, there's a 1 in 4 chance of rolling a 1; with a 20-sided dice, there's a 1 in 20 chance. Luckily, Sonic Pi has the handy `one_in` fn for describing exactly this. Let's play:

```
live_loop :different_probabilities do
  sample :drum_snare_hard if one_in(6)
  sleep 0.125
end
```

Start the live loop above and you'll hear the familiar random rhythm. However, don't stop the code running. Instead, change the **6** to a different value such as **2** or **20** and press the **Run** button again. Notice that lower numbers mean the snare drum sounds more frequently, while higher numbers mean the snare triggers fewer times. You're making music with probabilities!

Combining probabilities

Things get really exciting when you combine multiple samples being triggered with different probabilities. For example:

```
live_loop :multi_beat do
  sample :elec_hi_snare if one_in(6)
  sample :drum_cymbal_closed if one_in(2)
  sample :drum_cymbal_pedal if one_in(3)
  sample :bd_haus if one_in(4)
  sleep 0.125
end
```

Again, run the code above and then start changing the probabilities to modify the rhythm. Also, try changing the samples to create an entirely new feel. For example, try changing `:drum_cymbal_closed` to `:bass_hit_c` for extra bass!

Repeatable rhythms

Next, we can use our old friend `use_random_seed` to reset the random stream after eight iterations to create a regular beat. Type the following code to hear a much more regular and repeating rhythm. Once you

hear the beat, try changing the seed value from **1000** to another number. Notice how different numbers generate different beats.

```
live_loop :multi_beat do
  use_random_seed 1000
  8.times do
    sample :elec_hi_snare if one_in(6)
    sample :drum_cymbal_closed if one_in(2)
    sample :drum_cymbal_pedal if one_in(3)
    sample :bd_haus if one_in(4)
    sleep 0.125
  end
end
```

One thing I tend to do with this kind of structure is to remember which seeds sound good and make a note of them. That way I can easily recreate my rhythms in future practice sessions or performances.

Bringing it all together

Finally, we can throw in some random bass to give it some nice melodic content. Notice that we can also use our newly discovered probabilistic sequencing method on synths as well as samples. Don't leave it at that, though – tweak the numbers and make your own track with the power of probabilities!

```
live_loop :multi_beat do
  use_random_seed 2000
  8.times do
    c = rrand(70, 130)
    n = (scale :e1, :minor_pentatonic).take(3).choose
    synth :tb303, note: n, release: 0.1, cutoff: c if rand < 0.9
    sample :elec_hi_snare if one_in(6)
    sample :drum_cymbal_closed if one_in(2)
    sample :drum_cymbal_pedal if one_in(3)
    sample :bd_haus, amp: 1.5 if one_in(4)
    sleep 0.125
  end
end
```

MIKE'S PI BAKERY



MIKE COOK

Veteran magazine author from the old days and writer of the Body Build series. Co-author of *Raspberry Pi for Dummies*, *Raspberry Pi Projects*, and *Raspberry Pi Projects for Dummies*. magpi.cc/1NqldHU

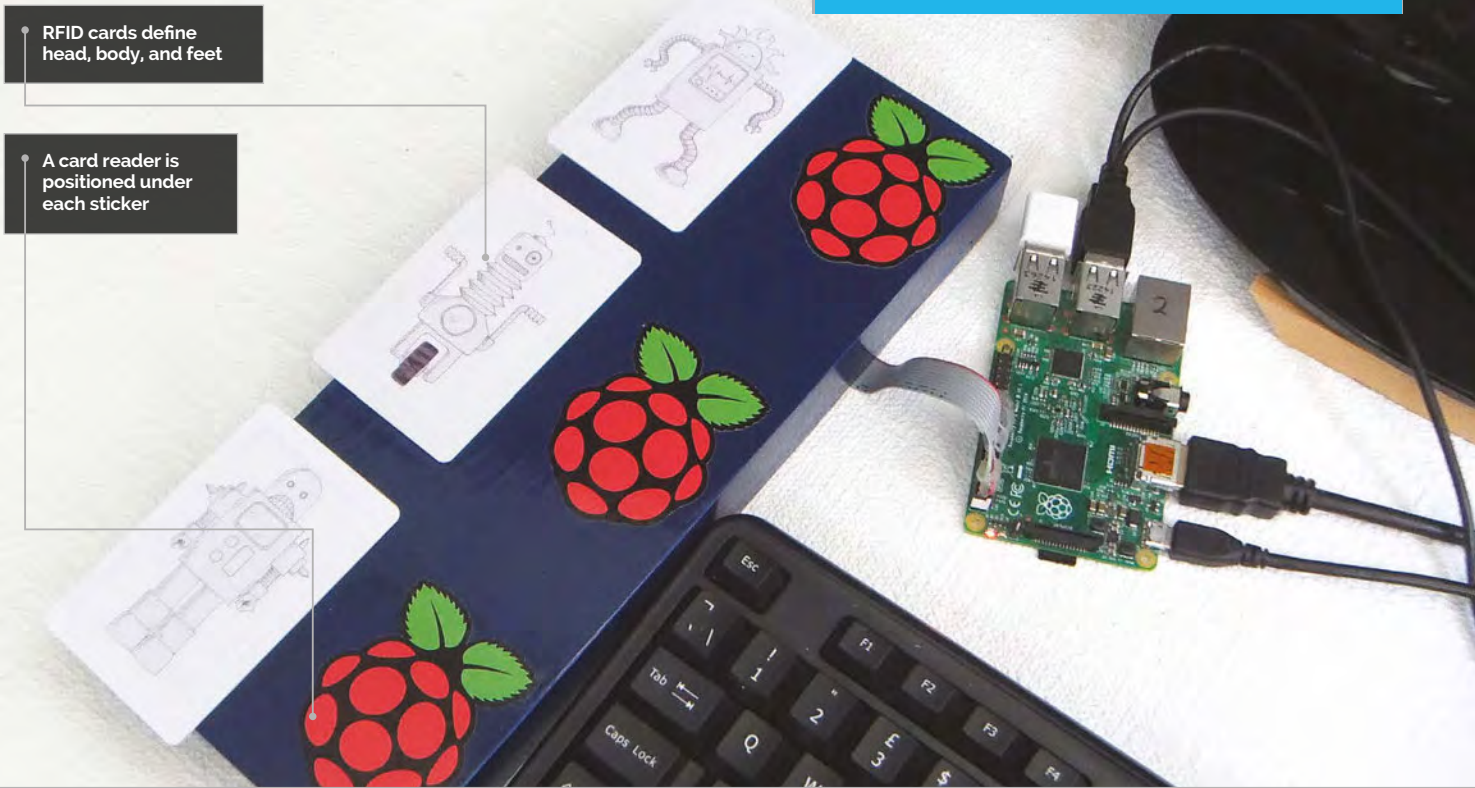

RFID cards define head, body, and feet

A card reader is positioned under each sticker

You'll Need

- > 3x RFID-RC522 Mifare card readers
- > 10x Mifare cards
- > 74HC4051 analogue switch
- > 16-pin DIL sockets
- > 24-hole by 11-hole stripboard
- > 3x 8-way right-angled pin headers
- > 26-way GPIO header socket
- > Assorted resistors, capacitors, and wires

MIXED UP

AN RFID PICTURE MAKING GAME



Make a Crazy Robot mash-up, with RFID cards

There's an increasing number of 'mixed-up' or 'mash-up' books, where a third of each page can be turned separately to reveal some crazy combination of drawings, like people with different clothes, dinosaurs or, as we have here, robots. The idea is that each complete robot is printed on an RFID card, but only a third of it is displayed, depending on what reader the card is placed on. This has always been a sure-fire hit whenever we have presented it at shows. Here is a low-cost Pi version; you can use the supplied artwork, or make a class project where everyone draws their own figure and they can all be combined. You can also add any number of background cards; one Mifare card can trigger one of three backgrounds, depending on the reader it's placed on.

The hardware

The low-cost RFID-RC522 reader is now widely available; we got three for less than £10 from one eBay supplier. While the chip itself is capable of interfacing in many ways, these inexpensive boards are configured such that you can only use an SPI interface. This is a little tricky for the Pi, as it only has two SPI Chip Enable pins. However, with the addition of an analogue switch, we can handle up to 16 readers easily; for this project we only need three. The schematic is quite straightforward and is shown in **Fig 1** (overleaf). All the RFID readers have their pins connected up, with the exception of the 'chip select pin', which is bizarrely labelled SDA. Full construction details are shown in the step-by-step boxes.

Make your own
robot mash-up

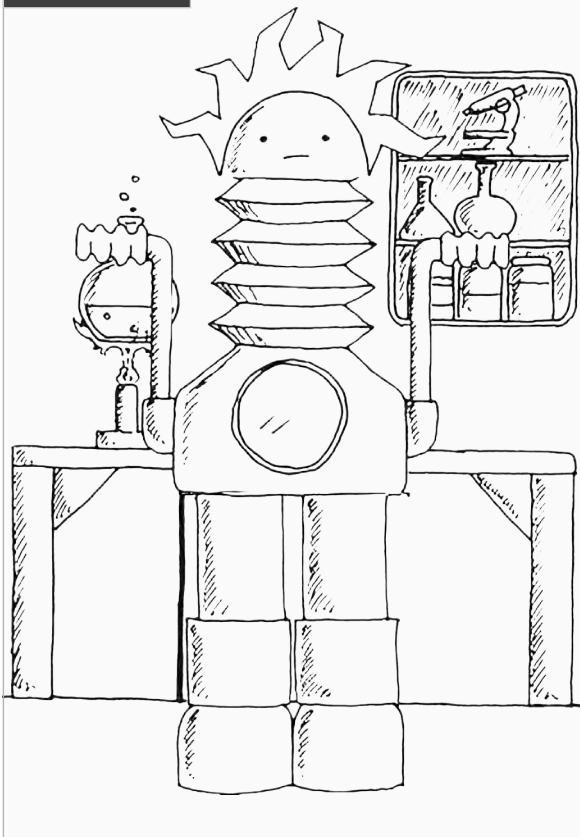

Gathering resources

The first thing you need is the artwork for the cards. This can be drawn as a class project, copied from a book or the internet, or you can use our artwork. We say ours, but we commissioned the robot drawings from an artist friend, Adam Farra; you can see them all in **Fig 2** (page 57) and download them from the GitHub repository for the project. If you're drawing your own artwork, it should end up as a PNG image 406 pixels wide by 615 pixels high. It's important that the height is divisible by three. They should also have a transparent background, so we can add our own in with other cards. There can be three background images for each background card.

You will also need to install an RFID library; we used the one at magpi.cc/28LleQN. The sample code is useful for testing your readers individually. When you're ready, move the **MFRC522.pyc** file into the folder that contains the **mixUp.py** code listing; this folder should also contain a directory called **Cards**, which contains the artwork files.

The software

The software runs under the Pygame framework and starts off by initialising that system. Each card causes its associated picture to be drawn, but through a different mask depending on the reader the card was seen on. In this way, only the head, body, or feet are drawn, depending on the reader used. The line

mixUp.py

```
#!/usr/bin/env python
# All Mixed Up by Mike Cook June 2016

import RPi.GPIO as GPIO
import MFRC522
import time, pygame, os, sys

pygame.init() # initialise graphics interface
os.environ['SDL_VIDEO_WINDOW_POS'] = 'center'
pygame.display.set_caption("All Mixed Up")
pygame.event.set_allowed(None)
pygame.event.set_allowed([pygame.KEYDOWN, pygame.QUIT])

screenWidth = 406
screenHeight = 615
screen = pygame.display.set_mode([screenWidth, screenHeight], 0, 32)

numberOfCards = 10 # picture cards
numberOfBacks = 3 # background cards
card = [ pygame.image.load("Cards/R"+str(cardNumber)+".png").convert_alpha()
          for cardNumber in range(0, numberOfCards+1)]
          # three background images for each card
          backgroundImage = [ pygame.image.load("Cards/B"+str(backNumber)+".jpg")
                              for backNumber in range(0, numberOfBacks*3)]
          # number of entries to match numberOfCards variable + 1
          tokens = [
0, 0x96e2acd5, 0xaa01a910, 0xbd51192b, 0xccb419de, 0xec9f19de,
0x5c6ccadd, 0x1c0201de, 0xcc0101de, 0x1c88fadd, 0xccba19de]
# number of entries to match numberOfBacks variable
backToken = [0x9c3131de, 0xbcc8eedd, 0xdc54e6dd]

headRect = pygame.Rect(0, 0, screenWidth, 164)
bodyRect = pygame.Rect(0, 165, screenWidth, 224)
feetRect = pygame.Rect(0, 384, screenWidth, 231)
headReader = 0; bodyReader = 1; feetReader = 2

GPIO.setmode(GPIO.BOARD)
GPIO.setwarnings(False)
muxPins = [16, 18, 7]
cardPresent = [False, False, False]
cardID = [0, 0, 0]
needRedraw = True
background = 0

def main():
    print "All mixed up"
    init()
    while 1:
        checkForEvent()
        if needRedraw :
            drawScreen()
            scanReaders()

def scanReaders():
    global cardPresent, cardID, needRedraw, background
```

Language

> PYTHON 2.7

DOWNLOAD:
magpi.cc/1NqJmV

PROJECT
VIDEOS

Check out Mike's
Bakery videos at:
magpi.cc/1NqJnTz



BUILDING THE CARD READER SYSTEM

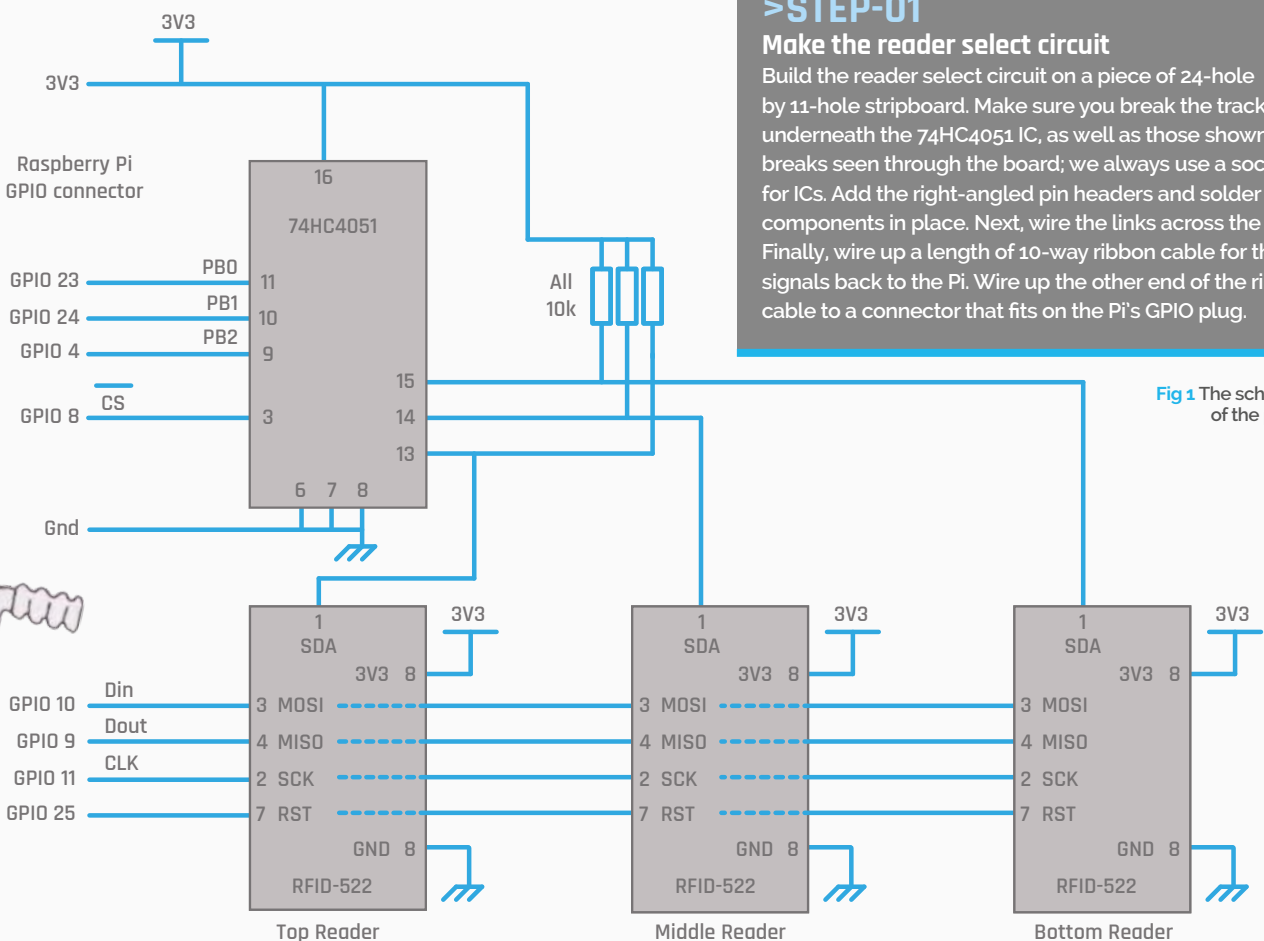
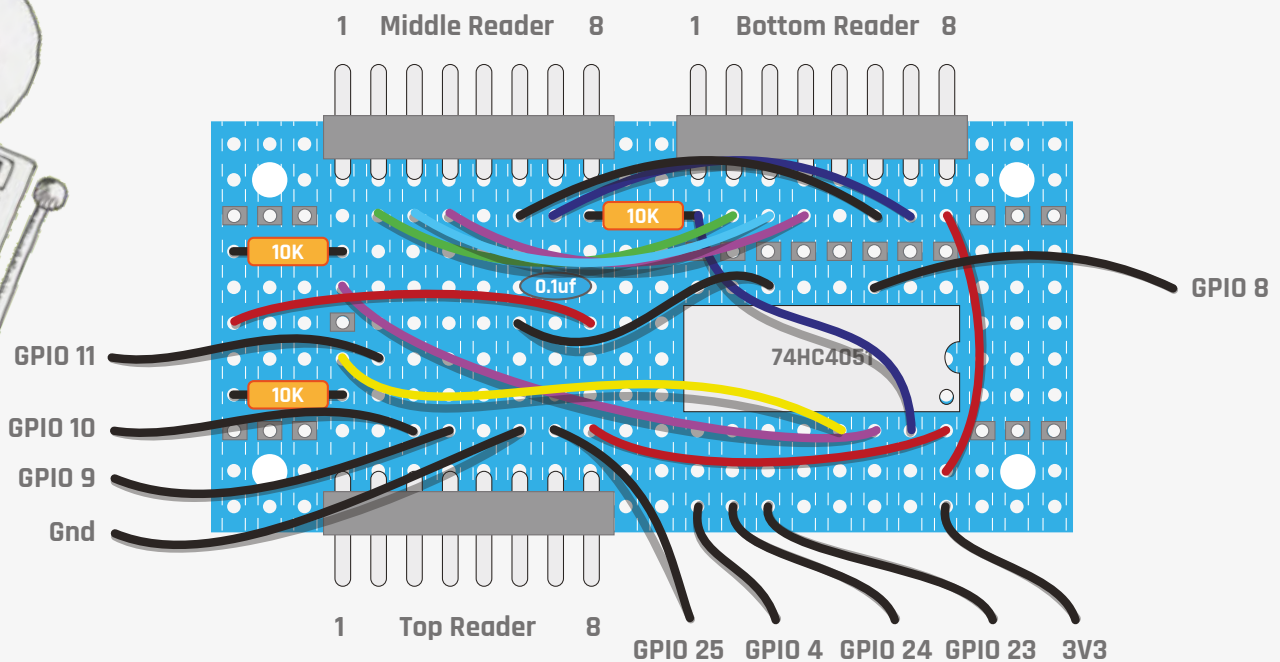

>STEP-01

Make the reader select circuit

Build the reader select circuit on a piece of 24-hole by 11-hole stripboard. Make sure you break the tracks underneath the 74HC4051 IC, as well as those shown as breaks seen through the board; we always use a socket for ICs. Add the right-angled pin headers and solder the components in place. Next, wire the links across the board. Finally, wire up a length of 10-way ribbon cable for the signals back to the Pi. Wire up the other end of the ribbon cable to a connector that fits on the Pi's GPIO plug.

Fig 1 The schematic of the project

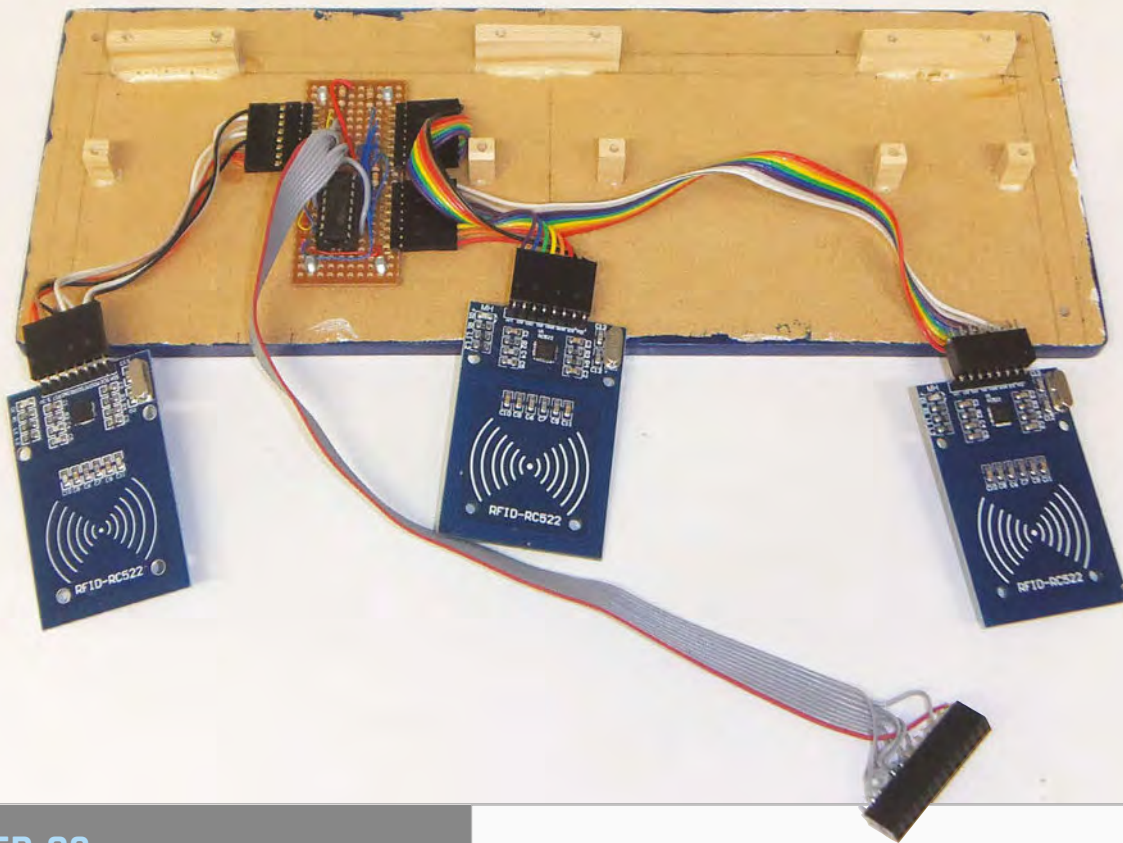

>STEP-02

Attaching the readers

First, solder the right-angled pin headers on the reader PCB. Now, make up lengths of 8-way ribbon cable connectors to connect to the reader switch. Mark each end of the cable with a small white dot so you don't get it the wrong way round. At this stage, it's worth testing that all three readers work. As the readers are affected by metal, it's important to use as little metal as possible in constructing the box. Also, the readers interfere with each other, reducing the range, so mount them at least 70mm apart.

that sets the **tokens** list will need changing to match the cards that you have. Run the code and present the cards to any reader to get a printout of the card's ID number. Next, copy and paste these numbers into the **tokens** list. Do the same for the background cards with the **backToken** list. Now run the program again and see what card generates what picture, then stick a printout of that picture on the card.

You can swap the reader associated with the head and feet by changing the **headReader** and **feetReader** variables. This needs to be done to make the display match the reader positions of the reader box if you have it the inverse way up. If the images you have drawn are not quite aligned, we have written a program to nudge them into place, which you can also find in the GitHub repo.

```
for reader in range(0,3):
    setMux(reader)
    (status,TagType) = mfRaeder[reader].MFRC522_Request(mfRaeder[reader].PICC_REQIDL)
    if status == mfRaeder[reader].MI_OK:
        (status,uid) = mfRaeder[reader].MFRC522_Anticoll()
        if status == mfRaeder[reader].MI_OK and cardPresent[reader] == False :
            cardPresent[reader] = True
            needRedraw = True
            token = (uid[0] << 24) | (uid[1] << 16) | (uid[2] << 8) | uid[3]
            if getImageNumber(token) != 0 :
                cardID[reader] = getImageNumber(token)
            else:
                setBackground(token,reader)
            print "Card reader",reader,hex(token).rstrip("L")
        else :
            cardPresent[reader] = False # no card present

def drawScreen():
    global needRedraw
    screen.blit(backImage[background],(0,0))
    screen.set_clip(headRect)
    screen.blit(card[cardID[headReader]],(0,0)) # change 0 to 2 for inverse
    screen.set_clip(bodyRect)
    screen.blit(card[cardID[bodyReader]],(0,0))
    screen.set_clip(feetRect)
    screen.blit(card[cardID[feetReader]],(0,0)) # change 2 to 0 for inverse
    screen.set_clip(None)
    pygame.display.update()
    needRedraw = False
```



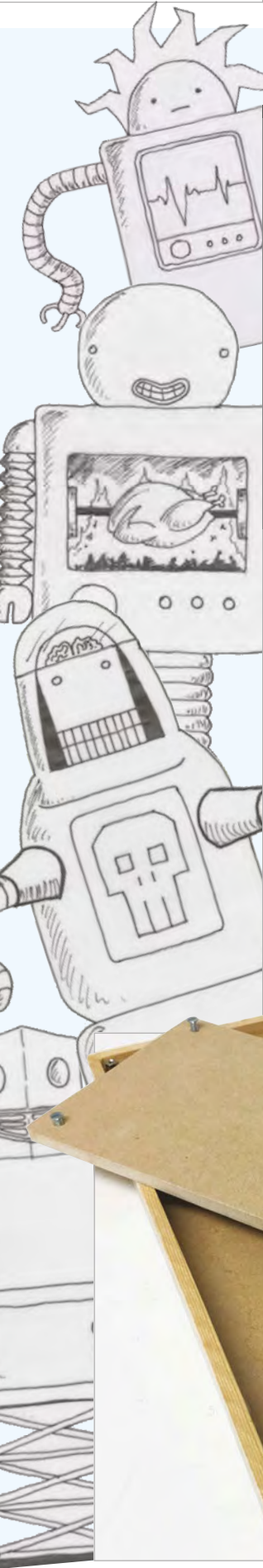

>STEP-03

Making the box

We used MDF to make the box lid and base, with 12mm strip pine for the sides. We made the base and top 280mm by 105mm, and used 10mm taped hex pillars to screw the base to the top. The sides were glued together and glued to the top; small blind recess holes were drilled in the top to give the glue something extra to grip on. We used the foaming Gorilla glue and held it together with clamps while it set. To get the spacing pillars to match up, clamp the base to the lid and drill through both at the same time. Note that the Gorilla glue requires damp joints, hence the water spray.

>STEP-04

Finishing the box

The box was assembled and the corners were given a small radius to remove any sharp edges. The readers were mounted on strip pine glued to the base, component side down, and attached with some small self-tapping screws. Make the reader come as close to the lid as possible to get the best reader range. The box was given a coat of MDF primer and then two coats of gloss paint. Finally, Raspberry Pi stickers were placed on the lid over each reader. Print out the robot pictures and glue them to the RFID cards; we also added a layer of transparent book-backing sticky back plastic for extra durability.

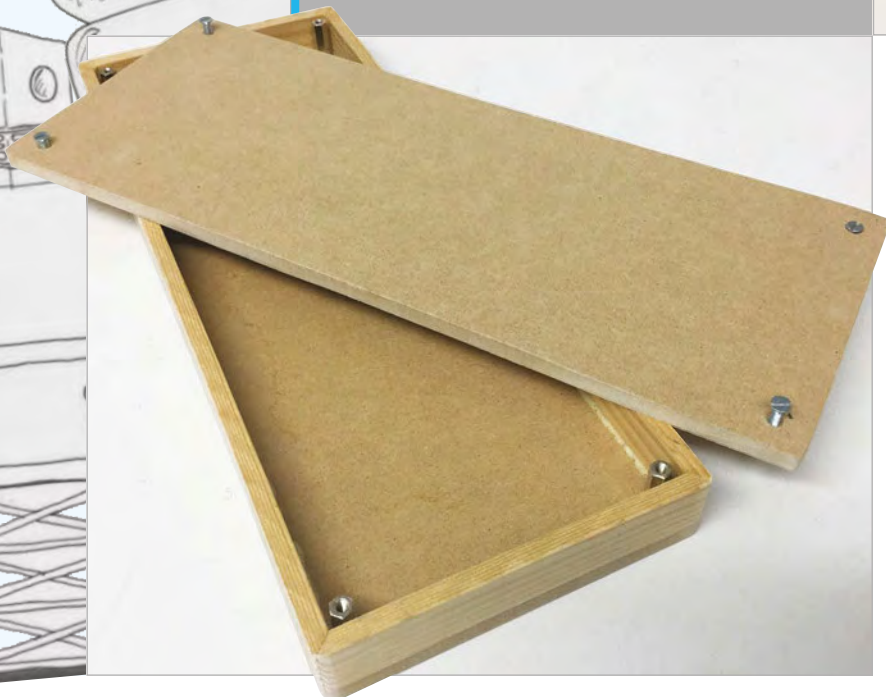

Taking it further

One simple, effective change would be to play a sound when a card is presented. Also, you could add an LED close to each reader that would flash when a card was presented. You also might want to add a print function so that you can get a hard copy of your mash-up. The artwork is a pencil sketch; how about using a paint program to colour it? One with a flood-fill paint bucket is easy-to-use. Keep to just a few matching colours for each robot; this enhances the craziness of the mixed up versions.

However, the great fun comes when you change the artwork completely. We did a version using the dinosaur images from a printed mix-and-match book; it also mixed up the syllables in the names to create a new one and the kids loved it. Not only did that involve new artwork, though, but also a change from portrait to landscape for the screen window. Are you up to that challenge?

Fig 2 The cast of crazy robots

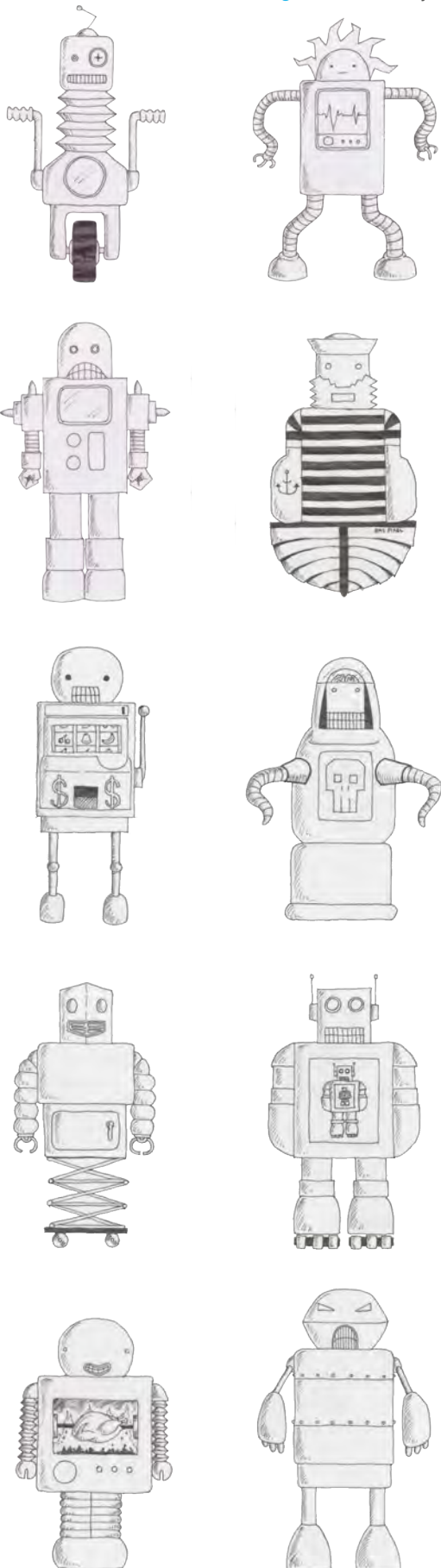

```

def getImageNumber(number):
    image = 0
    for i in range(0,numberOfCards+1) :
        if tokens[i] == number:
            image = i
    return image

def setBackground(token, reader):
    global background
    background = 0
    for i in range(0,numberOfBacks):
        if token == backToken[i]:
            background = reader + (i*3)

def init():
    global mFRaeder
    for pin in range (0,3):
        GPIO.setup(muxPins[pin],GPIO.OUT) # mux pin to output
    setMux(0)
    reader1 = MFRC522.MFRC522()
    setMux(1)
    reader2 = MFRC522.MFRC522()
    setMux(2)
    reader3 = MFRC522.MFRC522()
    mFRaeder = [reader1,reader2,reader3]

def setMux(n):
    mask = 1;
    for pin in range(0,3):
        if (mask & n) != 0 :
            GPIO.output(muxPins[pin], True)
        else :
            GPIO.output(muxPins[pin], False)
    mask = mask << 1

def terminate(): # close down the program
    print ("Closing down")
    GPIO.cleanup()
    pygame.quit() # close pygame
    os._exit(1)

def checkForEvent(): # see if we need to quit
    global nextF, background, needRedraw, cardID
    event = pygame.event.poll()
    if event.type == pygame.QUIT :
        terminate()
    if event.type == pygame.KEYDOWN :
        if event.key == pygame.K_ESCAPE :
            terminate()
        if event.key == pygame.K_SPACE : # reset display
            background = 0
            needRedraw = True
            for i in range(0,3):
                cardID[i] = 0

# Main program logic:
if __name__ == '__main__':
    main()

```



WESLEY ARCHER

Self-taught Raspberry Pi enthusiast, founder of Raspberry Coulis, and guide writer for Pi Supply and Cyntech. Enjoys trying out new Pi projects and sharing them!
raspberrycoulis.co.uk
 @RaspBerryCoulis
facebook.com/raspberrycoulis



Play your favourite video games using RetroPie

Download the files to laser cut your very own RaspCade cabinet like this one

MAKE A PROTOTYPE
 A prototype cabinet was made out of paper before laser cutting, to make sure it worked.

- You'll Need**
- > 7" LCD screen and HDMI driver board ([eBay](#))
 - > Picade PCB ([pimoroni.com](#))
 - > Zippy ball top arcade stick ([eBay](#))
 - > 2.8mm & 4.8mm Arcade daisy chain wires ([eBay](#))
 - > Female A panel mount USB socket ([eBay](#))
 - > 8x 30mm Arcade buttons ([modmypi.com](#))
 - > 2x 3-inch, 4-ohm, 3W speakers ([modmypi.com](#))
 - > Various 12.7mm stand-offs ([modmypi.com](#))

BUILD YOUR OWN ARCADE MACHINE



Ever wanted your own arcade machine? In this multi-part series, we're going to show you how to build your own RaspCade from scratch

The Raspberry Pi is a perfect choice for an arcade emulator, given its size, power, cost, and flexibility. There are many Pi-powered arcades available, some DIY and pre-built or kit-based, but in this multi-part special we'll be showing you how to build your own from scratch! Over the next few months, you will learn the basics of laser cutting your own cabinet, wiring together arcade controls, and setting up RetroPie for your very own home-made RaspCade! In this tutorial, we'll be looking at what you'll need to get underway...

>STEP-01

Plan your build

Before starting to build the RaspCade, we thought carefully about what would be needed and how to keep it simple. We used an LCD screen that was to hand, but any 7-inch screen should fit! The trickiest part was designing the cabinet, but this should now be as simple as downloading the files and getting them cut by a laser cutter. The parts list is not set in stone, but pay attention to dimensions, particularly the buttons and panel mount parts, as the cabinet is designed for our build in mind.

>STEP-02

Download the designs

To save you the hassle of making your own cabinet, you can download our designs (as a ZIP file) here: magpi.cc/28KV5Mn. The designs have been optimised for use with online laser cutting services, such as RazorLAB (Ponoko to our US readers), to keep things simple. Plastics require special solvents for this and can be quite messy, so 3mm MDF is recommended when cutting, because it's cheap and easy to glue together once assembled. If you want to tweak the designs to your liking, then you'll need Adobe Illustrator (or possibly Inkscape), as they are saved as EPS files.

>STEP-03

Don't overcomplicate things

As this is a DIY build, we highly recommend you keep things as simple as possible – at least for your first attempt, anyway. Arcade machines nowadays are full of flashing lights and enticing sound effects. Whilst this would be awesome, replicating this at home might be challenging. However, if you're feeling adventurous, then go for it! For example, in our build we are going to add NeoPixels driven by an Adafruit Trinket, and held by custom 3D printed mounts within the clear arcade buttons, but you don't have to do this if you aren't feeling confident.

>STEP-04

Software for the task

There are many options for emulation software to use on the RaspCade, but we'll be using RetroPie in this build and we recommend you do, too. RetroPie is very easy to set up and provides a fantastic front-end to our RaspCade. It's always being refined and updated by the developer, plus it can play a wide variety of games, so it makes an excellent choice for this project. You can download the latest version of RetroPie here: magpi.cc/25UDXzh.

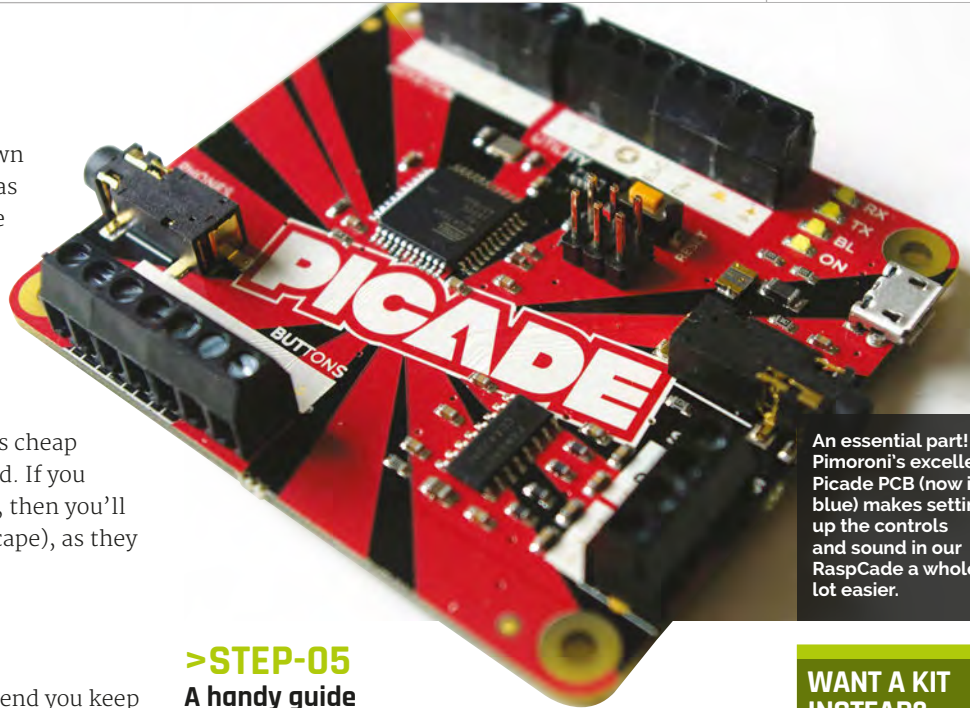

An essential part! Pimoroni's excellent Picade PCB (now in blue) makes setting up the controls and sound in our RaspCade a whole lot easier.

>STEP-05

A handy guide

If you're reading this thinking, "Why are there only eight buttons instead of ten?", or "I want flashing lights all over the place!", then feel free to only use this series as a guide. You don't need to follow it to the letter. As mentioned earlier, the cabinet design is based on the parts we have available, but if you're feeling creative, feel free to design your own cabinet or tweak the one in the design. We would love to see what you do with your build and hope you share them!

>STEP-06

What's next?

Now it's time to get all your parts so that you're ready for the next stage; most, if not all of them, should be able to be purchased online. Costs may well vary, but you should be able to find everything you need. In the next edition, we'll start building our controls. For this you'll definitely need the joystick, buttons, the arcade wiring harnesses, and the Picade PCB. We'll cover the basics of wiring up all your buttons, including the joystick, and how to use them with the Picade PCB for a hassle-free installation.

WANT A KIT INSTEAD?

If a DIY version is not for you, then why not check out Pimoroni's PiCade instead? magpi.cc/1U9cMLz

Below Some of the components we need in our build, including the obligatory joystick

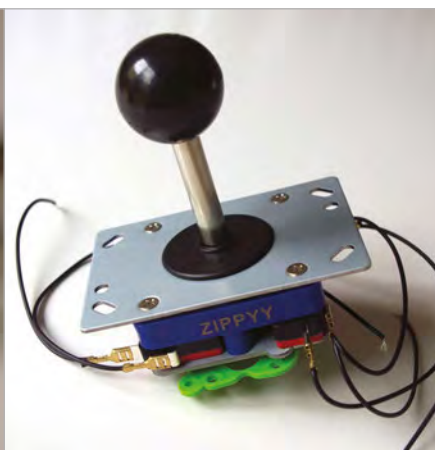



GARAGE TECH

Advocate of physical computing, digital fabrication, and tech recycling.
[garagetech.tips](#)
[@GarageTechTweet](#)

The LED bar with the resistor network is connected to the GPIO and will display your message

Using a spare case fan is a quick and easy way to get the spinning element

The USB 5V booster will power your Pi Zero with a LiPo battery

An old CD has been used as a platter on the fan, to hold the rest of the project

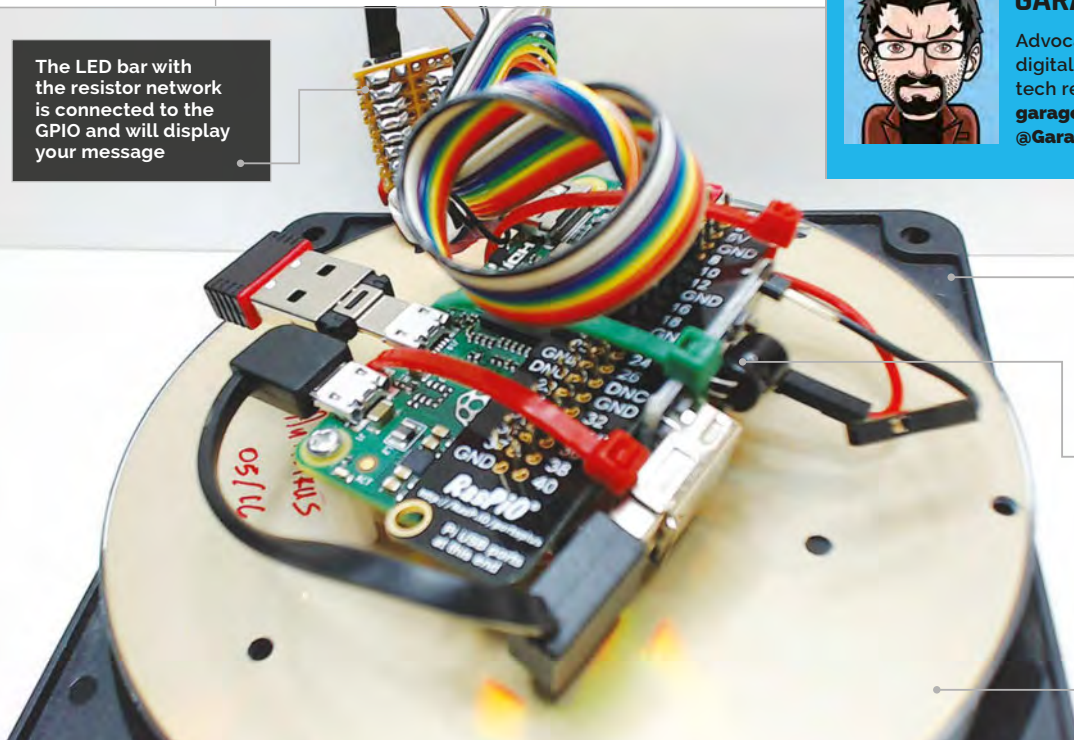

You'll Need

- > USB 5V voltage booster step-up module
[magpi.cc/1U5Fz0p](#)
- > LiPo battery charger
[magpi.cc/1U5F46y](#)
- > Lithium polymer battery – 1000mAh
[magpi.cc/1U5FkSP](#)
- > Nylon stand-offs
[magpi.cc/1WD2eVf](#)
- > Red LED bar graph display
[magpi.cc/1WD1tLN](#)
- > 220Ω SIL network - 8 commoned resistors
[magpi.cc/1WD1SxG](#)
- > 36-way header strip
[magpi.cc/1WD1YFA](#)
- > Case fan
- > Stripboard

WRITE TEXT IN THIN AIR WITH A PI ZERO

Create a persistence of vision illusion, an interesting project that's fairly easy to achieve and from which there is plenty to learn

In this article, we're going to show you how to build a Raspberry Pi Zero setup to display text from a file using an LED bar.

The fun part is that the Pi and all the rest of the hardware are spinning, glued onto a PC fan, to deliver a fantastic persistence of vision (POV) effect whilst remaining wirelessly connected to your network!

What is POV?

You can experience persistence of vision in many ways. From something as simple and obvious as a flip book or a film, to seeing car wheels spinning in the other direction, the principle is very similar. These are an illusion: what we perceive as motion is given by a series of discrete images shown to us at a specific rate. If the number of images per second is too low, we perceive them as just pictures; get the right frame rate and you see motion.

Persistence of vision with LEDs has been a thing for a while and has been perfected over time to extremely sophisticated levels.

Our example works with eight LEDs arranged in an LED bar and installed on a rotating platform. When the platform, our CD, starts spinning, an LED which is turned on will give the illusion of a bright disc. This is very similar to what happens when you start writing your name in the air with a sparkler on bonfire night.

Imagine that you're able to control the sparkler very precisely, and it can also be switched on and off at very precise moments during its motion. In such conditions, you could be able to see something that would remind you of Morse code.

In the same way, as the CD rotates, we'll be controlling our LED bar with very precise timings, and these will give you the impression of very complicated light patterns which we eventually use to display characters.

Building the POV

The most important part of getting this POV to run smoothly is the way you fix the system onto the CD. Placing the Pi Zero in the correct place will make it so that, when turning, the whole setup will have as few vibrations as possible. The rule of thumb we followed was to drill two 3mm holes on opposite sides of the central hole of the CD, so that they would sit on one of the disc's diameters. The two holes correspond to the ones on the Pi Zero's PCB, which are diagonally opposed to each other.

Fix the Pi with the spacers and install the rest of the components as shown in the picture. The LiPo battery gets tucked in under the Pi.

Be creative about how you fix things, and use the correct amount of Blu-Tack and cable ties.

We modified the LiPo battery terminals so that we could easily plug it into the charger without needing to take anything apart.

Use a spacer between the fan and the CD to keep things away from the fan frame. Lastly, put together the LED bar as shown in the picture below, following the corresponding colour and GPIO pin numbers.

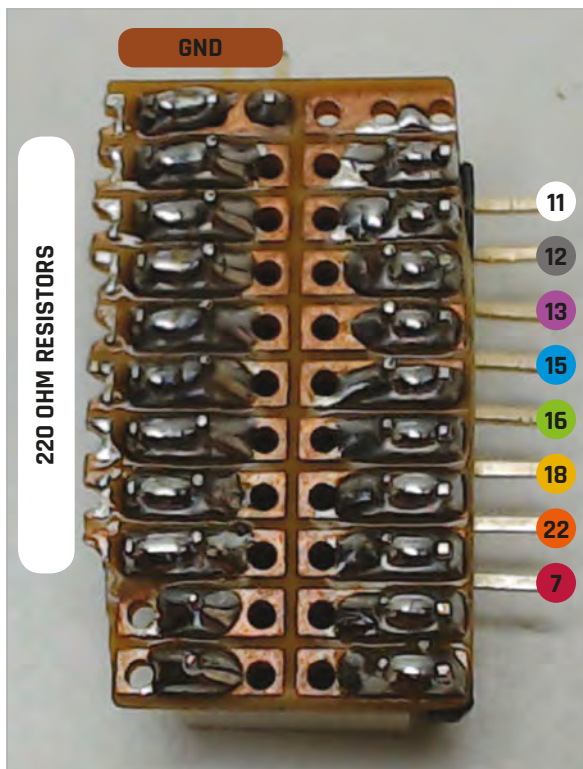

CONTAIN THE VIBRATIONS

Even the cable connected to the LED bar will introduce substantial imbalance if not properly anchored. Pull all the slack of the cable to the centre of the CD and fix it tightly so that it won't move once the disc is spinning. You might want to experiment, drilling a few holes to find the sweet spot for where to place the LED bar, but after a bit of trial and error you should have a stable enough setup.



Tuning the rotation speed

Getting the timing right works better by trial and error than by making very complicated calculations, and that's how we approached the problem. We needed to make it so that the frequency at which the PC fan is spinning, and the frequency with which we're switching the LEDs on and off, somehow converge on a point at which the illusion of floating text is convincing. We started by choosing about 5-6V with a bench power supply to power our 12V PC fan. That meant the fan was turning slower or faster, depending on the voltage selection of the power supply. In the meantime, we started by blinking one of the LEDs with some regular timing and went off to see if a dotted line was appearing instead of the bright disc.

Changing the timing between flashes helped us tune the dotted line so that it looked like a succession of bright and dark lines which appeared about the same length. Once we got there, it was just a question of putting together the right code to show the characters we wanted.

In your own setup, you will only need to adjust the voltage provided to the fan once the script is running, until you see something floating in the air.

Going for a spin

We provide the demo code `PiZeroPOV.py` on GitHub ([magpi.cc/1WD4ADE](https://github.com/magpi/cc/1WD4ADE)), which will display the contents of `pov.txt`. The script will check the contents of the text file every 10 seconds and display them on the POV. As the Pi Zero is connected to your network via its wireless adapter, you can change what's being displayed at any time without needing to shut down or alter the spinning system in any way. The only limitations of this demo script are that it only accepts lower-case characters and spaces – anything else will break it miserably, but, hey, anybody can easily improve it with a bit of time and dedication.

So, as you log into your rotating Pi Zero, just type:

```
sudo python PiZeroPOV/PiZeroPOV.py &
```

...and start editing `pov.txt` by using nano:

```
nano PiZeroPOV/pox.txt
```

This will get your messages in the air!

Above Have it write anything you want in the air – it looks better in real life than in photos!

Language
> PYTHON

DOWNLOAD:
magpi.cc/1WD4ADE

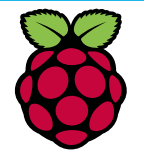

SIMON LONG

Works for Raspberry Pi as a software engineer, specialising in user interface design. In his spare time he writes apps for the iPhone and solves crosswords. raspberrypi.org

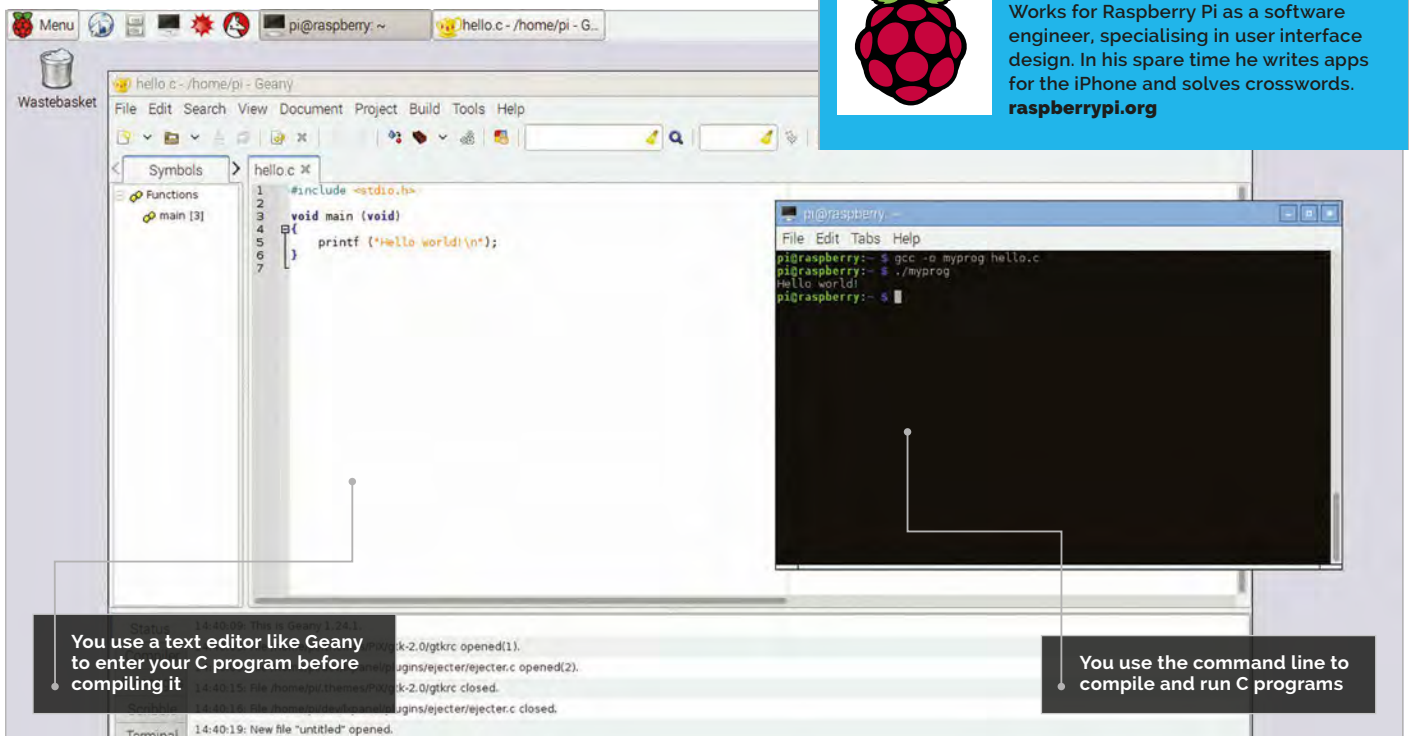

AN INTRODUCTION TO C

PART 01 GETTING STARTED

C is one of the most widely used programming languages – learn how to use it to program the Pi!

The C programming language has been around for several decades, and is popular both with hobbyists and in industry; it's been used to program everything, from the tiny microcontrollers used in watches and toasters up to huge software systems. In fact, most of Linux (and Raspbian) is written in it. It's a language which allows you to control the finest details of the processor, but is still simple to learn and read. This series is an introduction to C for absolute beginners; you don't need anything other than a Pi running Raspbian to get started.

What's so great about C?

C is a very powerful language – there's not much you can't use it for – but it's fairly simple. The language itself only has 20 or so keywords, but there's a huge library of additional functions that you can call in when you need them. In this series, we're going to concentrate on learning about the keywords, with a few of the more useful library functions thrown in for good measure.

Many of the languages that you may have seen, such as Python, are what are called interpreted

languages. This means that the code you write is run directly: each line of code is read in and interpreted as you run it. C is different: it's a compiled language. This means that the code you write, known as the source code, is never run directly. The source code is passed through a program called a compiler, which converts it into a machine-readable version called an executable or a binary; you then run the resulting executable.

This may seem complex, but it has a few big advantages. First, it means that you don't need to have a copy of C itself on every computer you want to run your program on; once compiled, the executable is standalone and self-contained. Second, the compilation process will find a lot of errors before you even run the program (but it won't usually find all of them!). Most importantly, the compilation process means that the time-consuming translation of human-readable code into machine-readable instructions has already happened, which means that compiled code generally runs many times faster than interpreted code would.

WHITESPACE DOESN'T MATTER!

Unlike Python, whitespace has no significance in C – you can put spaces, tabs, and new lines anywhere you like in a C program to make it readable.

Hello world – your first C program

With all that out of the way – which has hopefully made you think that C might be worth learning – let’s have a look at the first program everyone writes in any language: the one that prints ‘Hello World’ on the screen. Incidentally, the tradition of writing a Hello World program was first introduced with the original documentation describing C itself. Just think: no C, no Hello World...

```
#include <stdio.h>

void main (void)
{
    /* A print statement */
    printf ("Hello world!\n");
}
```

Hopefully not too frightening! Let’s look at it line by line.

```
#include <stdio.h>
```

This is known as a hash-include. As mentioned above, the C language has a large library of functions that can be included, and we need to use one of them in this program: the formatted print command **printf**. This is part of the standard input-output library, or **stdio** for short. So what this line does is to warn the compiler that the program needs the **stdio** library to be included as part of the compile process.

```
void main (void)
```

C is a function-based language; every program is made up of a number of functions.

Each function takes zero or more arguments, and returns a single value. A function definition consists of a specification of what the function returns (in this case, a ‘void’), a function name (in this case, ‘main’), and a list of arguments enclosed in round brackets (again, a ‘void’).

Every C program has to include a function called ‘main’; when you run the compiled program, the **main** function is the first thing that executes.

The word ‘void’ is called a type specifier; a **void** is a special type which means ‘no value required’. We’ll look more at types in the next instalment of this series.

So this line defines the **main** function for this program; it states that the **main** function takes no arguments, and returns no value.

The code which makes up the function itself is enclosed between the two curly brackets **{}** that follow the function definition.

First, we have a comment telling us what’s going on. Comments in C start with the symbol **/***, and end with ***/** – anything between those two symbols is ignored by the compiler.

```
/* A print statement */
```

The code itself is just one line:

```
printf ("Hello World!\n");
```

This is a call to the **printf** (‘print formatted’) function from the **stdio** library. In this case, it takes a single argument, which is a text string enclosed within double-quotes. As mentioned above, function arguments are enclosed in round brackets.

Note that the line ends with a semicolon. All statements in C must finish with a semicolon; this tells the compiler that this is the end of a statement. One of the most common beginner mistakes in C is to forget a semicolon somewhere!

What about the string itself? The ‘Hello World!’ bit is straightforward enough, but what about that ‘\n’ at the end? Remember this function is called print formatted? Well, the **\n** is a bit of formatting; it’s the symbol for a newline character. So this line will print the string ‘Hello World!’, followed by a new line.

Compiling your program

Let’s compile and run this. Raspbian includes a C compiler called **gcc**, so there’s nothing to install; just start up Raspbian on your Pi and you’re ready to go. Use your favourite text editor to create a file called **hello.c**, copy the program above into it, and save it. Then, from a terminal, go into the directory where you saved **hello.c** and enter:

```
gcc -o myprog hello.c
```

This calls the gcc C compiler with the option **-o myprog**, which tells it to create an executable output file called **myprog**, and to use **hello.c** as the input source code.

If you entered your C code correctly (did you make sure the semicolon was there?), this should take a second or so and then return you to the command line. There should now be a file in the current directory called **myprog** – try running it by typing:

```
./myprog
```

Et voila! You should now have...

```
Hello World!
```

...written in the terminal.

That’s your first C program written, compiled, and run. Next time, we’ll start using C for something a bit more useful...

```
File Edit Tabs Help
pi@raspberrypi:~ - $ gcc -o myprog hello.c
pi@raspberrypi:~ - $ ./myprog
Hello world!
pi@raspberrypi:~ - $
```

CHECK YOUR BRACKETS

Unlike whitespace, punctuation is very important in C – make sure you don’t use a curly bracket where a round one is needed, or vice versa.

CHOOSE YOUR EDITOR

You can use whatever editor you like to enter code, as long as it saves it as plain text. The Geany editor included in Raspbian is a good choice, but you can also use Leafpad, nano, or any others that you prefer.

RUNNING YOUR PROGRAM

You need to tell Linux that the program you want to run is in the current directory, so don’t forget the **./** before **myprog**, or it won’t know where to look!

Left You interact with both the C compiler and your compiled C programs from the command line; you can either do this in a terminal window in the desktop, or by booting your Pi straight to the command line



ALAN MCCULLAGH

Irish and French. Biggest Raspberry Pi supporter in Orange. Ambassador and national coordinator for Europe Code Week. Helping develop Code Club in France. @tyrower

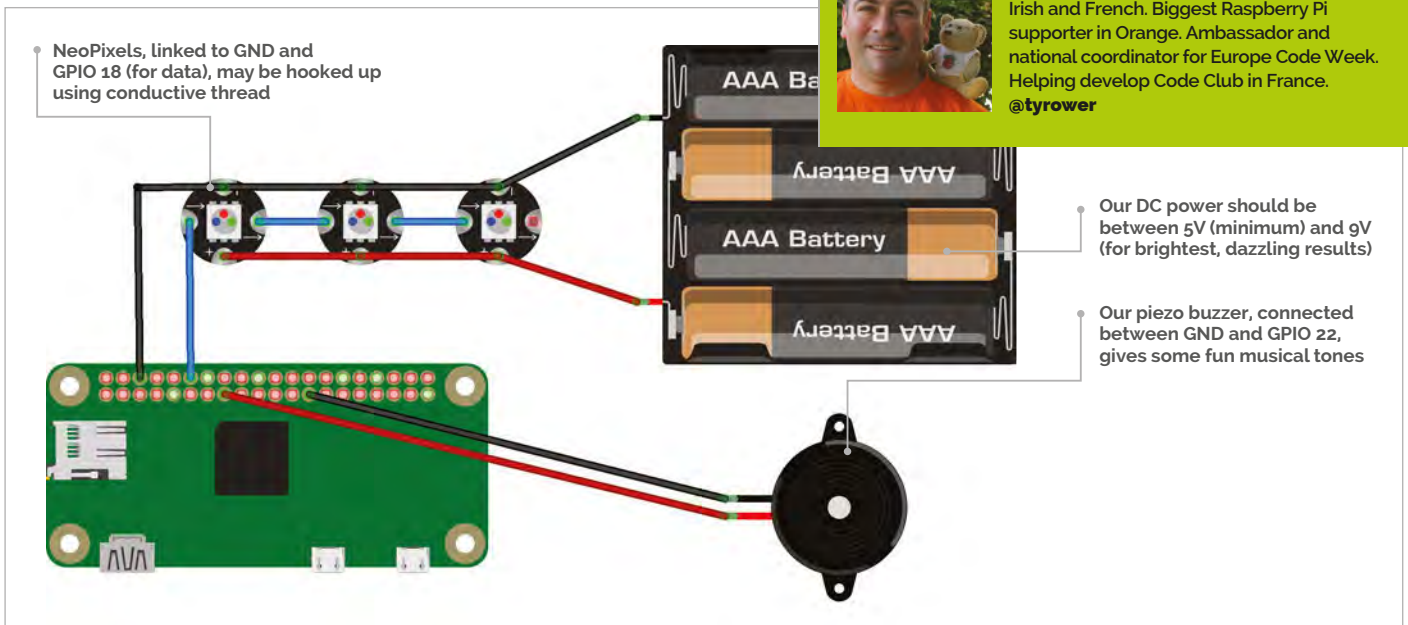

MAKE A RASPBERRY BERET

You'll Need

- > A hat – ideally a beret
- > Piezo buzzer magpi.cc/28ljubH
- > WiFi dongle magpi.cc/28ljAsZ
- > Battery packs (5V for Pi; 5-9V for NeoPixels)
- > Camera Module magpi.cc/28ljjsz
- > Pisoundo package, originally from onebeartoe magpi.cc/28ljRMy
- > Rpi_ws281x library from jgarff magpi.cc/28ljT6X

We'll add some wearable electronics to our hat: music, lights, camera, and some 3D prints in a digital homage to Prince

For some people hearing about the Raspberry Pi for the first time, a certain song entered their head. This earworm turned out to be the eighties classic *Raspberry Beret*. It's now become more poignant with the untimely departure in April 2016 of legendary musician Prince.

As far back as August 2011 in the forum, there was even a merchandising suggestion of a Raspberry (Pi) Beret. Since nothing came of it, we're going to hack our hat for some fun – adding colour, sound, and vision.

>STEP-01 Prepping the Pi

We start out with a fresh installation of Raspbian. Use the WiFi dongle to connect to the network. Make sure everything is up to date:

```
sudo apt-get update && sudo apt-get upgrade
```

Take note of the Pi's IP address:

```
hostname -I
```

We'll then be able to work remotely via SSH, and later point our smartphone or web browser at the Pi.

You could also find the IP via the graphical interface, a smartphone app (such as Fing), Bonjour via Mac, via a router admin page, or a tool such as Nmap.

>STEP-02 Making the sign (of the times)

If you have access to a 3D printer, you can creatively spruce up the hat with some colourful 3D prints. Prince famously became associated with a shape, later known as the 'Love symbol', even replacing his name at one time. We easily found a vector graphic (SVG) online (magpi.cc/28li66C), as created by onebeartoe. Bringing the file into Tinkercad (tinkercad.com), via **Import URL**, giving it a height in the process, allows us to generate a 3D printing file. We rescale it so our NeoPixels shine and our camera can shoot through it. We must then generate our final 'G-Code' file to be printed.

>STEP-03 What it sounds like when piezos cry

The piezo is no simple buzzer. Much like phones of old, we can program it to play very basic tunes, although don't expect quality – it's more like a novelty musical Christmas tie than high-fidelity.

First, check the version of Java (it should be 1.8):

```
java -version
```

If needed, install/upgrade via:

```
sudo apt-get install oracle-java8-jdk
```

The latest JAR package of our Raspberry Beret version of Pisoundo can be downloaded and copied to the Pi from magpi.cc/28IqaUQ.

If you've already hooked up the piezo as in the schematic, you can launch the application via :

```
sudo java -jar pisoundo-0.0.1-Raspberry-Beret.jar
```

From the network, we then point a browser at [http://\[IP_address_of_Pi\]:2111/ui/index.html](http://[IP_address_of_Pi]:2111/ui/index.html) and choose a tune from the list. Alternatively, it's possible to inject your own musical code by clicking on the On-the-Fly link on the page.

>STEP-04

Add some lights

Having hooked up our individual NeoPixels, as per the diagram, we need to carry out the following commands to get our lights on and flashing.

```
sudo apt-get install build-essential
python-dev git scones swig
https://github.com/jgarfff/rpi_ws281x.git
cd python
sudo python setup.py install
```

In the example given, we see three NeoPixels, but you can choose to add as few or as many as you want (individual, rings, or strands). To configure this, type:

```
cd examples/
sudo nano strandtest.py
```

Then adjust the following line to suit your setup:

```
LED_COUNT = 3 # Number of LED pixels
```

Finally, to launch our program, use:

```
sudo python ./strandtest.py
```

Our LEDs should start to flicker, dance, and change colour.

>STEP-05

Cameras, action...

A final step is to hook up our Camera Module to take photos or even broadcast a live video stream. One of the easiest ways is with the RPi Cam Web Interface

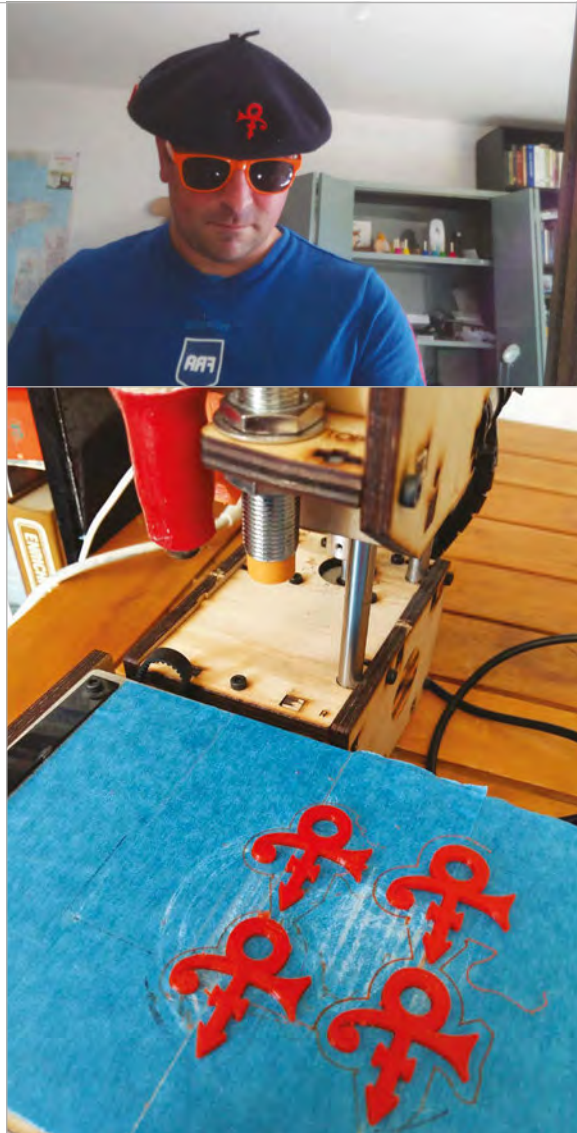

Language

>PYTHON

DOWNLOAD:
magpi.cc/28IqenE

Left Placing the piezo on the top, NeoPixels around the edge, and camera on the front, we add our 3D 'symbols' for a final Princely touch

Left Printing off 3D decorative symbols adds colour to our headwear and hides our electronic connections. Hot glue is our friend when attaching them

LE BERET BASQUE

The beret is often thought of as French, but for us it's usually more associated specifically with Basque regional tradition.

(magpi.cc/28InKFJ). Don't forget to activate the camera via the **Configuration** menu on the **Interfaces** tab. Here's a simple installation method:

```
git clone https://github.com/
silvanmelchior/RPi_Cam_Web_Interface.git
cd RPi_Cam_Web_Interface
chmod u+x *.sh
./install.sh
```

Once we've set this up, all we need to do is point a web browser at the IP address of our Pi to access the RPi Cam Control.

>STEP-06

Explore the possibilities

If you tested out this project on a breadboard to get it working, it's now time to install all the electronics inside our hat. Use your imagination to modify and make it better. Hack the hat. What else could we add to our chapeau?

So now we have a Raspberry Beret – the kind you wouldn't find in a second-hand store. Enjoy!

THE MELON HAT

In France, they think of the bowler hat as being British. A fruit connection – it's called a 'melon hat' in French!

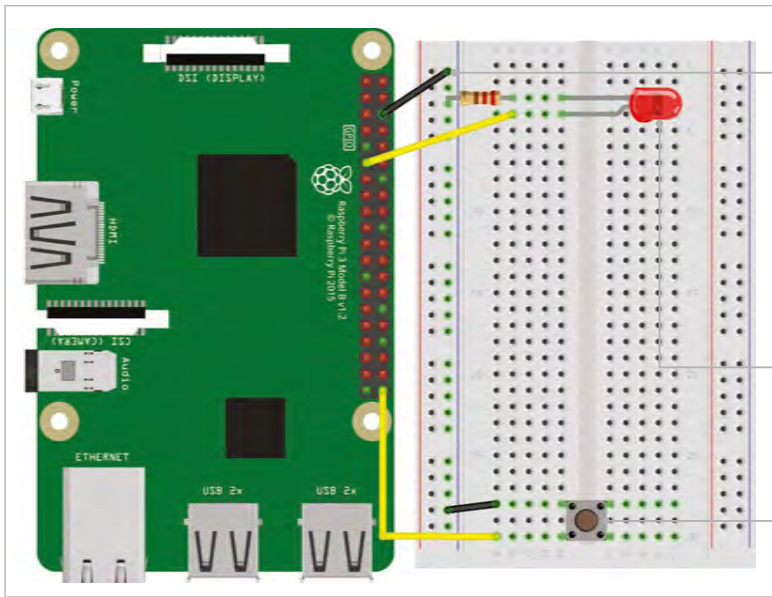

PHIL KING

When not sub-editing *The MagPi* and writing articles, Phil loves to work on Pi projects, and to help his six-year-old son learn Scratch coding.
@philking68

By wiring the '-' row, or ground rail, to a GND pin, multiple components can share the connection

The LED's longer leg is wired to GPIO 17, while the other is connected via a resistor to the ground rail

When the button is pressed, the circuit is broken and Scratch senses a zero value from GPIO pin 21

LIGHT AN LED

Scratch can be used with the Pi's GPIO pins for physical computing projects. Here, we'll hook up a button-activated LED

You'll Need

- > Solderless breadboard
- > LED
- > 333Ω resistor
- > Push button
- > 3× male-to-female jumper wires
- > Male-to-male jumper wire

In the latest version of Raspbian Jessie, Scratch features a built-in GPIO server to make it easier to control electronic components or add-on boards. In this first GPIO tutorial, we'll be creating a simple circuit with a button that, when pressed, causes an LED to light up. Take a look at the 'You'll Need' box to see which electronic components are required; you can buy them separately, but they're all in the CamJam EduKit #1 (magpi.cc/10cXtim).

>STEP-01

Connect the LED

It's advisable to turn the Pi off when building your circuit. The breadboard features numbered columns, each comprising five connected holes. Place your LED's legs in adjacent numbered columns, as shown in the diagram. Note that the shorter leg of the LED is the negative end; in its breadboard column, insert one end of the resistor, then place the other end in the outer row marked '-' (the ground rail). Use a male-to-female jumper wire to connect another hole in that ground rail to a GND pin on the Pi. Finally, use a jumper wire to connect a hole in the column of the LED's longer (positive) leg to GPIO pin 17.

>STEP-02

Configure Scratch GPIO

Before we can use the GPIO pins from Scratch, we need to turn its GPIO server on. While this can be done from the Edit menu, instead we'll get our code to activate it. Under a **when green flag clicked** block, add a **broadcast** Control block, click its arrow, select new/edit, and enter **gpioserveron**. We also need to configure GPIO pin 17 as an output pin (to trigger the LED), so add another **broadcast** block and change it to **config17out**.

Left This project is simple to wire up using a solderless breadboard and some jumper wires

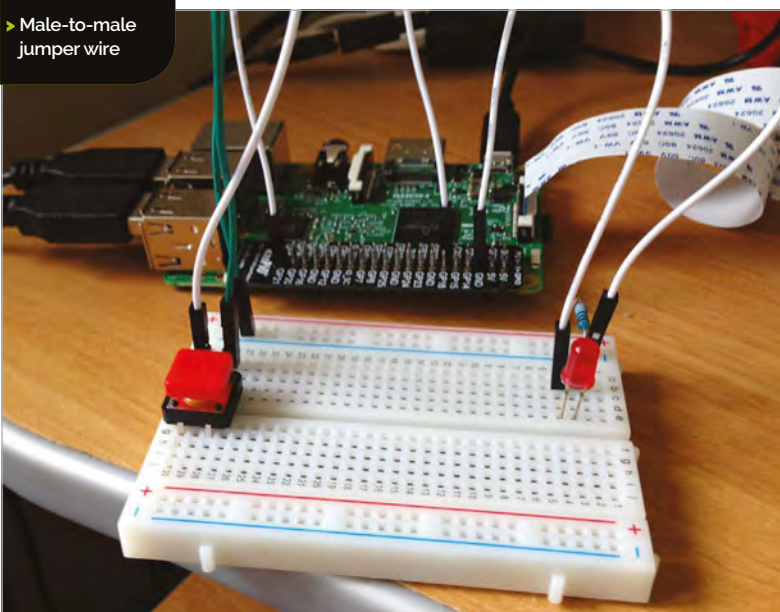

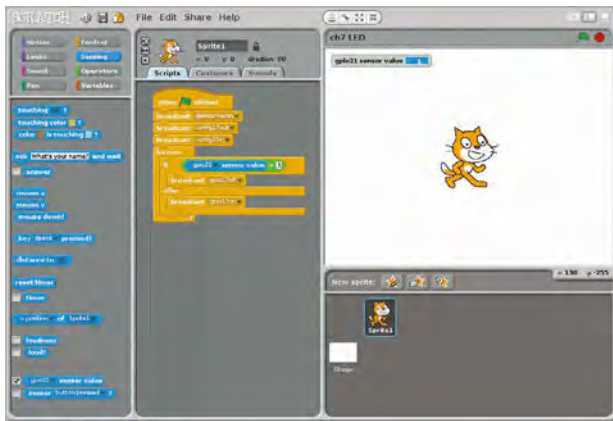

Above Ticking the button's gpio21 sensor value will show it on the stage, which is handy for testing

>STEP-03

Light the LED

We'll now test our circuit by using a loop to make the LED blink. Add a **forever** block to the bottom of your code. Within it, add the following blocks: **broadcast gpio17on**, **wait 1 secs**, **broadcast gpio17off**, and **wait 1 secs**. Now try running the code (shown in Listing 1): your LED should blink on and off repeatedly.

>STEP-04

Connect the button

We can control our LED by adding a push button. Again, we'd advise you to turn the Pi off while connecting new components. Add the push button to the breadboard, with its pins straddling the central groove (as shown in the diagram). Connect a male-to-female jumper wire from one pin's column to GPIO pin 21 on the Pi. Connect a male-to-male jumper from the other pin (on the same side of the groove) to the ground rail you're using for the LED circuit (to share its connection to the GND pin).

>STEP-05

Configure button

Before Scratch can react to your new button, it needs to be told which pin is its input. Delete the **forever** loop from your blinking LED code by dragging it out of the Scripts area. Add another **broadcast** block with **config21in** to configure GPIO pin 21 as an input (see Listing 2). Run and stop the code. Now, click the Sensing category in the top-left pane. Find the **sensor value** block and change it to **gpio21**. Click its tickbox to show its value on the stage: whenever the button is pressed, it should change from 1 to 0.

>STEP-06

Link to LED

With the button working, it's time to make it trigger the LED. Add the code from Listing 3 to the end of your code. Again, we're using a **forever** block for a continual loop. Inside it we add an **if...else** block.

.01

```

when clicked
broadcast gpioserveron
broadcast config17out
forever
broadcast gpio17on
wait 1 secs
broadcast gpio17off
wait 1 secs
    
```

.02

```

when clicked
broadcast gpioserveron
broadcast config17out
broadcast config21in
    
```

.03

```

forever
if gpio21 sensor value = 1
broadcast gpio17off
else
broadcast gpio17on
    
```

.04

```

when clicked
broadcast gpioserveron
broadcast config17out
broadcast config21in
forever
if gpio21 sensor value = 1
broadcast gpio17off
else
broadcast gpio17on
    
```

In the **if** field, we place an = Operator block; in its left field, we add **gpio21 sensor value**, with 1 in the right field. Underneath, we insert **broadcast gpio17off**. This way, when the button isn't pressed, the LED will be off. Under **else**, we insert **broadcast gpio17on**, to light the LED when the button is pressed. Run the code (as in Listing 4), press that button, and watch your LED! In the next tutorial, we'll add more LEDs to the circuit to make a pedestrian crossing.



PHIL KING

When not sub-editing *The MagPi* and writing articles, Phil loves to work on Pi projects, and to help his six-year-old son learn Scratch coding.
@philking68

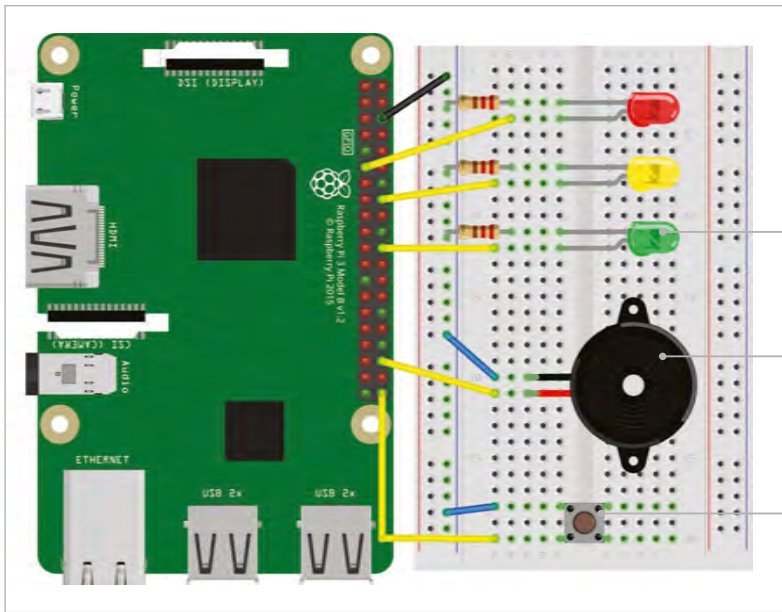

- Each LED is connected to a different GPIO pin, so it can be triggered during the traffic light sequence
- A piezo buzzer is wired up to the ground rail and GPIO pin 16 to make our pedestrian crossing beep
- When the button is pressed, the circuit is broken and Scratch senses a zero value from GPIO pin 21

LED TRAFFIC LIGHTS

We use three LEDs and a push button to make a pedestrian crossing

You'll Need

- > Solderless breadboard
- > 3× LEDs: red, yellow, and green
- > 3× 333Ω resistors
- > Push button
- > Piezo buzzer
- > 5× male-to-female jumper wires
- > 2× male-to-male jumper wires

In the latest version of Raspbian Jessie, Scratch features a built-in GPIO server to make it easier to control electronic components or add-on boards. In this second GPIO tutorial, we'll create a pedestrian crossing with some traffic lights and a sound alert using LEDs, a push button, and a buzzer. Again, all the components required are in the CamJam EduKit #1 (magpi.cc/10cXtim).

>STEP-01 Connect the LEDs

It's best to turn the Pi off when building your circuit. The breadboard features numbered columns, each

comprising five connected holes. Add the LEDs to it, as shown in the diagram. If you still have the setup from the previous tutorial, you can leave those components, including the red LED, in place. As before, the shorter (negative) leg of each LED should be connected via a resistor to the '-' row (common ground rail), which is wired to a GND pin on the Pi. Each LED's longer (positive) leg should be connected to the respective GPIO pin via a male-to-female jumper cable.

>STEP-02 Configure Scratch GPIO

First, we need to turn on Scratch's GPIO server. Under a **when green flag clicked** block, add a **broadcast Control** block, click its arrow, select new/edit, and enter **gpioserveron**. We also need to configure our LEDs' GPIO pins as outputs, so add three more **broadcast** blocks and change them to **config17out**, **config23out**, and **config25out** respectively. While we're at it, we'll configure the pins for the buzzer (**config16out**) and button (**config21in**) we'll use later. Your code should look like Listing 1.

>STEP-03 Traffic light sequence

We'll now test our circuit by creating a traffic light sequence: red, red/amber, green, amber. Add the code from Listing 2. Here, within a **forever** block, are blocks to turn the LEDs on and off in the correct sequence, waiting a few seconds between each change. Try running it to check that all the LEDs are connected correctly and working.

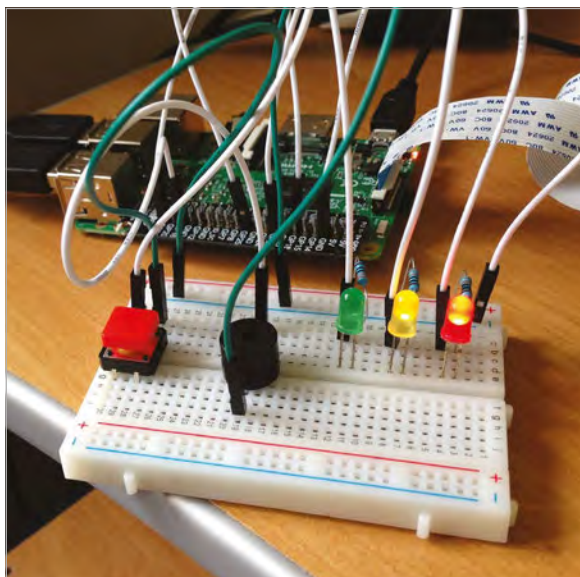

Right While there's quite a jumble of wires, it's relatively easy to connect all the components



Above Four pieces of code are used: for GPIO configuration, light sequence, button press detection, and buzzer beeping

>STEP-04

Connect the button

For our pedestrian crossing, we'll need a push button. Again, you can use the one already placed in the previous tutorial, which straddles the central groove of the breadboard and is connected to the ground rail and GPIO pin 21. We've already configured it as an output in step 2; run and stop that code. Now, click Sensing in the top-left pane. Find the **sensor value** block and change it to **gpio21**. Click its tickbox to show its value on the stage: when the button is pressed, it'll change from 1 to 0.

>STEP-05

Stop the lights

We need to get a button press to cause the traffic lights to stay on red for a few seconds. Select Variables from the top-left, then click 'Make a variable' and enter 'pushed' in the text field. Add the code from Listing 3, keeping it separate from the rest. Using an **if** block, this sets **pushed** to **True** when the value sensed from GPIO pin 21 is zero, i.e. when the push button is pressed.

Next, we need to add an **if...else** block to our traffic light sequence code, to stop it when **pushed** is **True**. After moving the light sequence blocks out of the **forever** block (keeping them in the Scripts area), add in an **if...else** block and put the light sequence blocks back under **if**. In the **if** field, use an = Operator block with **pushed** in the left field and 'False' in the right. Under **else**, add a **broadcast and wait** block set to 'beep'; we'll be using this for our buzzer in the next step. Your light sequence code should now resemble Listing 4.

>STEP-06

Add a buzzer

Finally, we'll add a piezo buzzer, connected to the ground rail (short leg) and GPIO pin 16 (long leg), to make a beeping noise when it's safe to cross the road. Add the code from Listing 5 separately. This runs whenever **beep** is broadcast, after the button is pressed and the light sequence ends. It shows a red light and uses a **repeat** loop to turn the buzzer on and off for a beeping sound. Finally, it turns off the red LED and resets the **pushed** variable to **False**. Test out your pedestrian crossing by pressing the button!

.01

```

when clicked
broadcast gpioserveron
broadcast config17out
broadcast config23out
broadcast config25out
broadcast config16out
broadcast config21in
  
```

.03

```

when clicked
set pushed to False
forever
if gpio21 sensor value = 0
set pushed to True
  
```

.02

```

when clicked
forever
broadcast gpio17on
wait 5 secs
broadcast gpio23on
wait 2 secs
broadcast gpio17off
broadcast gpio23off
broadcast gpio25on
wait 5 secs
broadcast gpio25off
broadcast gpio23on
wait 2 secs
broadcast gpio23off
  
```

.04

```

when clicked
forever
if pushed = False
broadcast gpio17on
wait 5 secs
broadcast gpio23on
wait 2 secs
broadcast gpio17off
broadcast gpio23off
broadcast gpio25on
wait 5 secs
broadcast gpio25off
broadcast gpio23on
wait 2 secs
broadcast gpio23off
else
broadcast beep and wait
  
```

.05

```

when I receive beep
broadcast gpio17on
repeat 10
broadcast gpio16on
wait 0.5 secs
broadcast gpio16off
wait 0.5 secs
broadcast gpio17off
set pushed to False
  
```

FREQUENTLY ASKED QUESTIONS

NEED A PROBLEM SOLVED?

Email magpi@raspberrypi.org or
find us on raspberrypi.org/forums
to feature in a future issue.

Your technical hardware and software problems solved...

HOME GROWN ASTRO PI

HOW CAN I MAKE AN ASTRO PI?

Print a case

You can 3D print a replica of the Astro Pi flight unit currently in use on the International Space Station. It fits a Raspberry Pi with a Sense HAT and can be found on the Astro Pi site: magpi.cc/28KOC8h

Add some buttons

The Astro Pi case has specific buttons on the ISS that you can also buy down on Earth. These need to be wired up to the Raspberry Pi, and there's a learning resource on where to get the buttons and how to connect them: magpi.cc/28KfzFn

Alternative buttons

The buttons used on the flight cases aren't the only ones you can use (they can be a little expensive) – any tactile push buttons can be used, although you may need to file the case down for it to fit.

Below A beautiful 3D print of the Astro Pi case, sans hardware

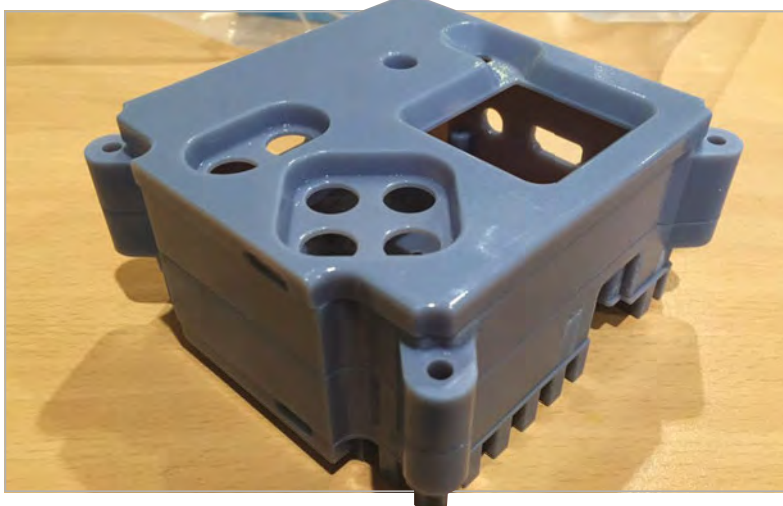

CAN I RUN THE EXPERIMENT CODE?

Grab the code

All the code for Astro Pi is open-source and available to download from the Astro Pi GitHub (github.com/astro-pi). With the case and buttons, you can run the games and some of the experiments that require the sensors, but you'll have to run them manually.

Camera experiments

Some of the experiments require the Raspberry Pi camera, mainly the standard camera such as in Crew Detector; however, EnviroPi needs an IR camera (Pi NoIR) and a blue filter to run properly. You may need to take photos from a plane, though!

Master control program

On the ISS, astronauts such as Tim Peake selected the programs using the joystick and buttons, thanks to a special selector program. The code for it isn't available yet, but you can always program your own in Python.

HOW DO I FIND THE ASTRO PI MUSIC?

Get the MP3 players

The 2016 competition called for MP3 players, and these are available on the Astro Pi GitHub (github.com/astro-pi) as well. You'll need to plug in speakers or headphones to listen to anything on them, though.

Space tunes

Several pieces of music were composed and sent up to Tim to listen to on the Astro Pi. You can find these on the Raspberry Pi SoundCloud page (soundcloud.com/raspberrypi). Take a listen and maybe you'll find a new favourite track.

Programme your own music

The music for these challenges was created on Sonic Pi (sonic-pi.net). We've had many tutorials about Sonic Pi in the magazine (including this issue). Indeed, we also have a book filled with Sonic Pi tutorials, which can be found here: magpi.cc/MagPiStore

FROM THE RASPBERRY PI FAQ RASPBERRYPI.ORG/HELP

What SoC does the Raspberry Pi use?

All versions and revisions of the Raspberry Pi, other than the Raspberry Pi 2B/3B, use the Broadcom BCM2835. This contains an ARM1176JZFS with floating point, running at 700MHz, and a VideoCore IV GPU. The GPU is capable of Blu-ray-quality playback, using H.264 at 40Mbps. It has a fast 3D core, accessed using the supplied OpenGL ES2.0 and OpenVG libraries. The Model 2B uses the Broadcom BCM2836. This contains a quad-core ARM Cortex-A7 processor with floating point and NEON, running at 900MHz, and the same VideoCore IV GPU that's in the other models of Raspberry Pi. The Model 3B uses the Broadcom BCM2837, containing a quad-core ARM Cortex-A53 running at 1.2GHz. Its GPU capabilities are equivalent to the Pi 2.

Why was the ARM1176JZFS selected?

Cost and performance factors.

What is an SoC?

A System on a Chip (SoC) is a method of placing all necessary electronics for running a computer on a single chip. Instead of having an individual chip for the CPU, GPU, USB controller, RAM, northbridge, southbridge, and so on, everything is compressed down into one tidy package.

How does the Raspberry Pi boot?

All the files necessary for booting are installed in a FAT32 partition of the SD card. The Raspberry Pi has to have an SD card installed to boot from, but a USB HD can 'take over' after the initial boot. You cannot boot without an SD card.

Do you sell a self-assembly kit?

No. It would be too expensive for us to provide kits alongside finished boards, which would mean introducing another step in manufacturing. A kit would also be impossible to hand-solder. We use special equipment (robots!) to solder on the BGA package and other tiny components.

THE MAGPI APP

Having trouble with *The MagPi* on the App Store or Google Play? Here are your most common questions answered:

How do I find *The MagPi* on Google Play or the App Store?

All you have to do is go to the search bar and type 'The MagPi' or 'Raspberry Pi' to find us.

I've subscribed to the digital edition and I can't sign in to restore my purchases. Please help!

Since your *The MagPi* purchases are linked to your Google or Apple accounts, there's no need to sign in at all. If you'd like to re-download your purchases on your current device, or make your purchases available on other devices, all you need to do is press 'Subscribe' on the home screen, then 'Restore Purchases' on the next screen.

How can I search the digital magazine for keywords?

Finding direct references is really easy with *The MagPi* app: all you have to do is tap the screen to get the app's GUI to show, and then press the small magnifying glass icon in the top-right corner of the screen. Just type in your search term to find the relevant results.





PET TECH PROJECTS

Create something for your critter with these amazing Raspberry Pi projects for pets



We love to see cool projects that combine technology and cute critters here at Raspberry Pi Towers. After all, pets are family, and we love Raspberry Pi projects designed around our four-legged (or more) friends.

There have been some great examples over the last few months, so we thought it'd be a great idea to herd them all into one giant feature to show you our favourite pet-themed projects.

Raspberry Pi builders are a quirky bunch, and we've got pet projects for all kinds of pets. Cat owners will love Jasper's Cat Exercise Wheel, David Bryan's Pi-Powered Cat Feeder, and John Shovic's MouseAir. Dogs will go all waggy-tailed for Matt Reed's Sniffur or David Hunt's Pi-Rex.

Some of the best projects here put animals on social media: Kate Bevan's Tweeting Cat Flap and Henry Conklin's Twitter for Dogs both allow pets to interact online (by moving or barking).

We've also included a cool project for smaller creatures. Will McGugan's Beetlecams monitors the nocturnal movements of elephant beetles.

There are some super projects here, so put some food in your pet's bowl and settle down to figure out what to make.



JOHN SHOVIC

Dr John C Shovic is the chief technical officer and co-founder of SwitchDoc Labs. He has also served as a Professor of Computer Science at Eastern Washington University, Washington State University, and the University of Idaho.

Left There have been two versions of the MouseAir. The second edition uses the Raspberry Pi Camera to detect nearby cats

MOUSE AIR

When it sees a cat, it flings a toy mouse! That's the basic premise behind this brilliant cat-detecting mouse launcher

YOU'LL NEED

- ▶ Pi Camera Module
- ▶ Servo motors
- ▶ DC motors

Cats love chasing mice, which is why so many cat owners wake up with unwanted presents on their doorsteps.

If your cat is a hunter, then check out John Shovic's brilliant MouseAir project (magpi.cc/22MIwq3). This Raspberry Pi build keeps a cat's urge to chase after mice in check by flinging toy mice for it. "The goal of the project," says John, "is to be able to detect a cat walking by and fire a mouse. It worked!"

It may not surprise you to learn that the idea was conceived in a bar. The MouseAir was dreamt up in the Fedora in Coeur d'Alene, Idaho. "It was named by Sarah, the most excellent bartender there, and some Blue Moon beer," John discloses.

MouseAir combines a Pi Camera Module with a Mouse Loading System and Mouse Launching System (which flings toy mice into the air). "The Mouse Loading System is a conveyor belt, driven by servo motors, that drops the mice into the Mouse Launching System," explains John.

The Mouse Launching System is two rapidly spinning DC motors. These fling the mouse for the cat to chase.

"We're using a Pi Camera on a pan-and-tilt structure to capture the cat events, examine the launching mechanism for jams, motion detection, and stream video," says John. "The conveyor belt is the last thing that needs a little work."

"I had so much response to the project (including the response from my cat) that I decided to do a redesign of MouseAir, incorporating what I had learned from the project. I aggressively redesigned to eliminate unneeded hardware, and drive down the cost and size."

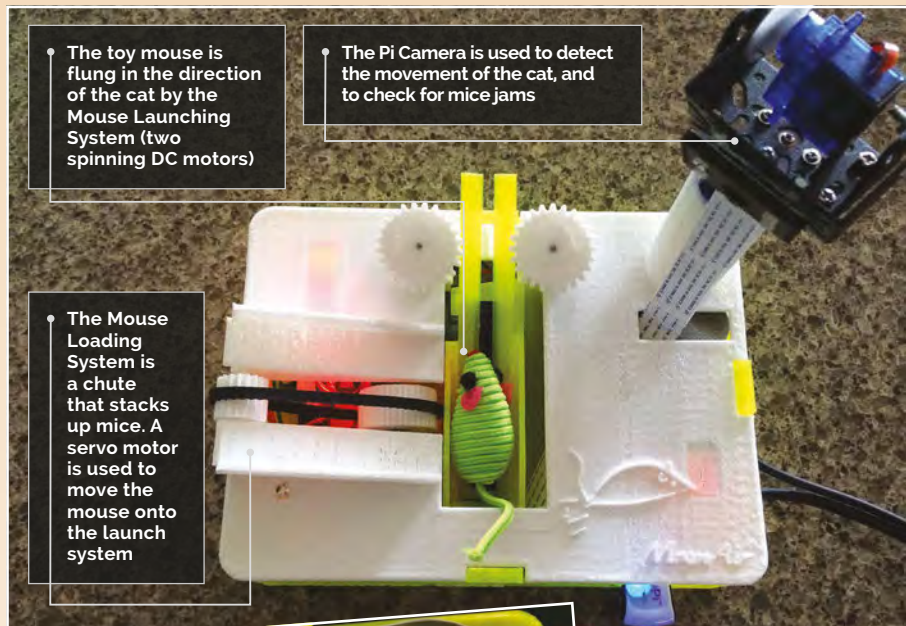

- The toy mouse is flung in the direction of the cat by the Mouse Launching System (two spinning DC motors)
- The Pi Camera is used to detect the movement of the cat, and to check for mice jams
- The Mouse Loading System is a chute that stacks up mice. A servo motor is used to move the mouse onto the launch system

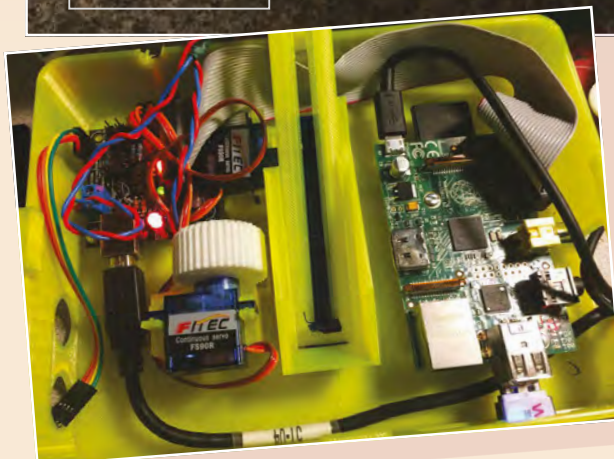

Left The MouseAir's 3D printed case houses the Raspberry Pi and servo motor

BARK DETECT

Wuf! Bark! Grrrr... this Raspberry Pi takes a dog's barking and tweets it online

Henry Conklin's dog, Oliver, can share his barks using Twitter thanks to the Bark Detect project (magpi.cc/28KCBxd). "My dog Oliver has always been quite vocal," explains Henry, "and recently I decided that his thoughts and comments needed to be shared with the world. Thus, the @OliverBarkBark project was born."

By connecting a Raspberry Pi, WiFi dongle, and microphone, Henry was able to make a system that "automatically detected, filtered, and published each and every one of Oliver's deafening vocalisations."

The Bark Detect is much more advanced than it appears. "I took a machine learning approach to filter out the barks," reveals Henry. "I built a model using pyAudioAnalysis (magpi.cc/1VKsITG) and a day's worth of barks. I then set up a Bash script to run every ten minutes and classify each recorded sound."

Below Machine learning is used to detect which noises belong to Oliver



The barks are forwarded to the Twitter API using python-twitter (magpi.cc/1VKsGet) and posted under the handle @OliverBarkBark: be sure to follow! Currently, the tweets are random strings composed of 'bark', 'ruff', and 'woof'. "I plan to replace that with a bark-to-text translator that will likely produce similar results, but be much closer to Oliver's actual voice."





Every time Daphne heads through her cat flap, it snaps her picture and tweets about it

FLAPPY MCFLAPFACE

Daphne announces her arrival to the whole world every time she saunters through her cat flap

All cats think they're special, but only Daphne has her very own Twitter-enabled cat flap that heralds her arrival online. The Flappy McFlapface project snaps a photo and tweets it, along with a cute randomised phrase.

Built by Bernie Sumption, this cat flap is a thing of beauty. "Daphne often takes to social media to rant about the inadequate service provided by her staff (tech journalist Kate Bevan)," explains Bernie on his blog (magpi.cc/1VKui85). "This activity is cathartic and highly recommended for any household pet. Unfortunately, Daphne's cat flap was until recently mute, and couldn't tell the world about its thoughts and feelings."

A £3 reed switch from Maplin provides the input. "This is wired to the GPIO sensors, using a couple of resistors that prevent the Pi from being damaged by drawing too much current. The reed switch is duct-taped to the cat flap so that when Daphne walks through, the voltage on a GPIO pin changes and the software can spring into action."



Left A generative grammar Python program creates tweets for the Flappy McFlapface

The Raspberry Pi uses a generative grammar program to create a tweet for Daphne. "It works by taking a standard sentence structure and replacing nodes in the sentence with one of several options," says Bernie. Tweets include 'Most exquisite Daphne, how soft is your magnificent fwuff. I can expire without regrets,' and 'Oh my! It's Daphne, how noble is your imperial demeanour. No wall-mounted fixture could be luckier than me.' You can follow Flappy McFlapface on [@DaphneFlap](https://twitter.com/DaphneFlap).

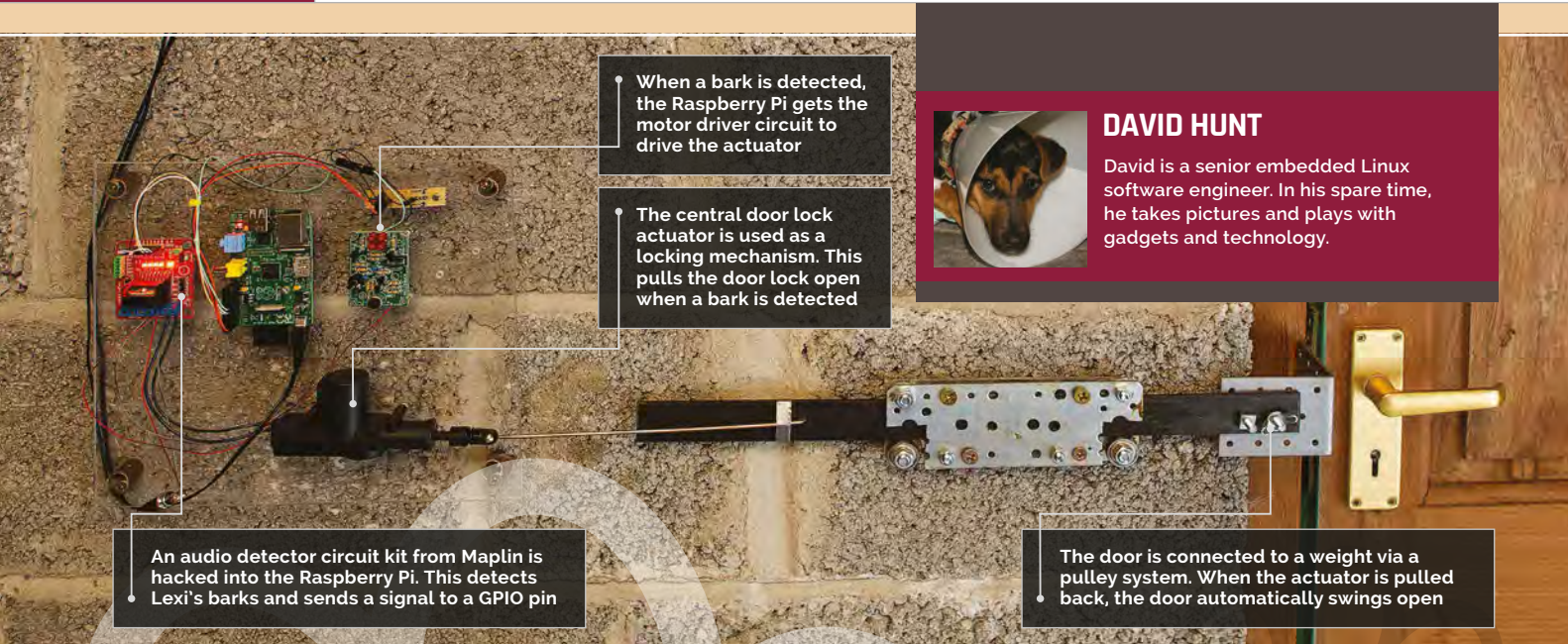

When a bark is detected, the Raspberry Pi gets the motor driver circuit to drive the actuator

The central door lock actuator is used as a locking mechanism. This pulls the door lock open when a bark is detected

An audio detector circuit kit from Maplin is hacked into the Raspberry Pi. This detects Lexi's barks and sends a signal to a GPIO pin



DAVID HUNT
David is a senior embedded Linux software engineer. In his spare time, he takes pictures and plays with gadgets and technology.

The door is connected to a weight via a pulley system. When the actuator is pulled back, the door automatically swings open

YOU'LL NEED

- > Central door lock actuator
- > Angle bracket
- > Motor driver PCB

PI-REX

One dog's bark is enough to open doors on command

David Hunt's dog Lexi has her very own door. The Raspberry Pi inside Pi-Rex listens for Lexi's bark and opens the door for her. "Sleep deprivation has been driving me mad," says David. "It's all down to a new member of the family, our new dog. She [Lexi] barks at night when she's left out. She barks early in the morning when she's left in."

David decided to build a bark-activated automatic door opener. A noise detector circuit is wired to the input of the Raspberry Pi to detect barks. A motor driver circuit drives the actuator that unlocks the door, and a weight and pulley system swings the door open when it's unlocked.

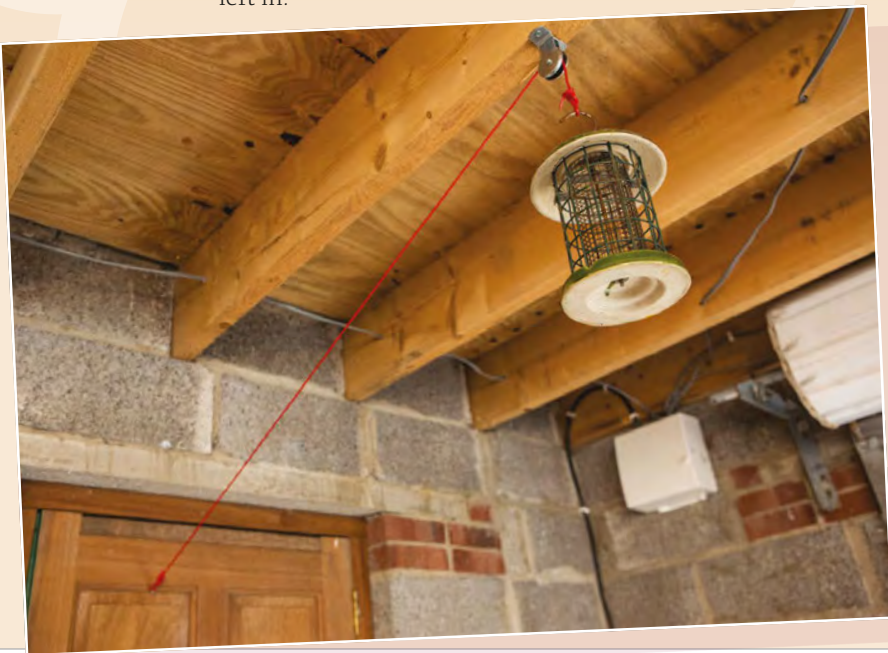

"I picked up the audio detection circuit in Maplin as a DIY kit," David tells us. "I probed the audio sensor with a voltmeter; when the volume into the microphone was at a decent level, I saw about 3-3.5 volts at one point, so I hooked that directly up to the GPIO on the Raspberry Pi, and it worked beautifully."

"I had a few pieces of metal lying around, and an angle bracket which got around the concrete blocks nicely to meet the door lock. I added a couple of bearings to reduce the friction on the mechanism; I didn't want to burn out the actuator. When it was built it was still a little stiff, so I greased it up and it was then moving nice and smoothly."

Now whenever Lexi barks, the door opens automatically to let her into the house (magpi.cc/28KAM3z).

Left The door is connected to a weight via a pulley system. When the actuator moves back, the door automatically swings open

K9

One of our readers has built Doctor Who's robot dog

What if you want to build a pet tech project, but don't have a pet? Well, you could use your Raspberry Pi to build your very own dog.

And if you're going to build a dog, why not go with the best robot dog that ever existed: Doctor Who's K9? Richard Hopkins is an IBM Distinguished Engineer, and he's spent a lot of time bringing K9 to life. "Most people would probably start with something simple, but that's not my style," says Richard. "Sink or swim. My first robot will be as near a facsimile of Doctor Who's dog K9 as I am capable."

The K9 build is based on the K9 schematics from the *Doctor Who* props department, and made from MDF. It's a work in progress, and detailed instructions can be found on Richard's blog (magpi.cc/28J6O21).

Richard has also purchased several remote-control K9 toys from eBay, but

ended up building his version of K9 with motors from an electric scooter. "The servos used for the tail and ears are simply not powerful enough to move a fairly substantial robot around," explains Richard. So he uses e-scooter motors connected to an H-bridge to move the robot around.

K9 is a lot smarter than most robots. "One of the original goals of building K9 was that he should have a Siri-like function for when he's not a remote presence robot," Richard says. "Apple has put quite a bit of money into developing Siri, so getting an equivalent function working on a Pi is a big ask." Fortunately, Steven Hickson has created a very clever voice command capability, specifically tuned for the Pi, as part of the PiAUISuite (magpi.cc/22MLXNr). Behind the scenes, it uses Google voice recognition and Google Translate text-to-speech software to enable the Pi to understand simple spoken commands and respond using voice.

"I've managed to get the basics working," reveals Richard. "You can now hold a conversation with K9, even if there are some embarrassing pauses while he thinks."

YOU'LL NEED

- ▶ E-scooter motors
- ▶ IR sensors
- ▶ Node-RED
- ▶ PiAUISuite



The Raspberry Pi inside controls K9 and powers the dashboard screen on his side. It also connects to the Pi Camera sitting behind his red eyes

K9 features Sharp infrared proximity sensors attached to his rotating ears. These look forwards and to the sides, and enable K9 to navigate his environment

The robot uses Siri-like voice analysis to hold conversations and act on his master's commands

Inside the body are motors recycled from an electric scooter. These have enough power to move the heavy robot around

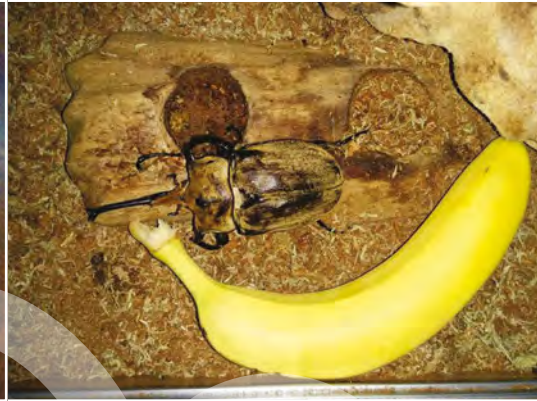
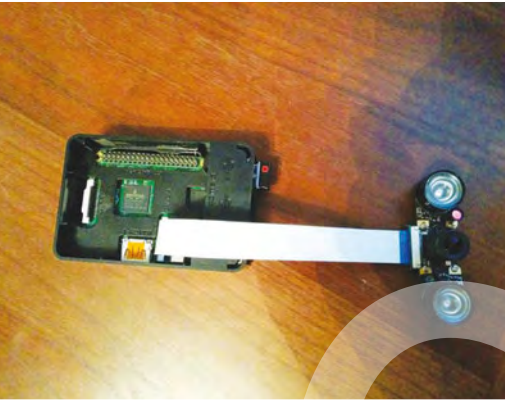

The Beetlecam is mounted on the roof of the elephant beetles' tank using Velcro tabs

BEEETLECAM

Monitoring nocturnal insects with a Raspberry Pi Camera

Elephant beetles may not be the most strokeable pets, but Will McGugan is a freelance software developer in Edinburgh who loves them all the same. “These insects are mostly nocturnal,” he tells us. “During the day, they tend to burrow under their bedding material or hang out on a branch. But during the night, they can be quite active. I know this because

in the morning they have rearranged the branches in their tank.”

Will wanted to make use of the Pi’s Camera Module to create a webcam. “I also wanted to be able to create time-lapse movies, because I didn’t want to watch 12 hours of video to see what they get up to at night.” The result was Beetlecam (magpi.cc/22MLURG).

SNIFFUR

Keep track of your pet, using beacons to triangulate their position

We looked at Matt Reed’s Sniffur project back in issue 42, and it’s still an impressive piece of kit. Sniffur uses a Bluetooth beacon and Raspberry Pis to triangulate the position of Bean, the dog at Matt’s office. But all dogs like to get out and play. “When [greyhounds] do, they’re very hard to catch because they’re so fast,” says Matt. “The need to know where she is at any moment and see if she’s close to the front doors is the reason Sniffur was built.”

Three Raspberry Pis are used to monitor the beacon device attached to Bean’s collar (magpi.cc/28L5NIe).



Left A beacon is attached to Bean’s collar, and three Raspberry Pi devices are used to triangulate the dog’s position

CATWHEEL

Build a giant hamster wheel for your moggy

We looked at Jasper's Cat Exercise Wheel in issue 45, and it's still one of the coolest pet tech projects around. This giant mechanised wheel uses a laser pointer to attract cats, and then a motor turns the wheel (youtu.be/dbPTwevy1SA). The Pi gathers data on motion and reports back via a web interface.



Keep your cats trim with this smart exercise wheel

PETBOT

Keep an eye on your pet with this open-source robot

PetBot (petbot.com) is the only commercially available project here, but don't worry: it's all open-source, and you're free to use the source code to build your version (or buy a pre-built kit). PetBot trundles around the floor of your house and enables you to interact with your pets from afar. It comes with a remote-controlled webcam, image recognition software, and treat dispenser, and is powered by the Raspberry Pi.

Play with your pet remotely with PetBot, a robot designed for pet interaction



The Raspberry Pi periodically activates servos that dispense food into the cat's bowl



PI-POWERED CAT FEEDER

Keep your cat fed with this automated cat feeder

Anybody with a cat knows how useful a cat feeder is. David Bryan took things one step further by building this Pi-powered cat feeder (magpi.cc/28KAD01).

"It's simple," says David, "and can be easily assembled in about 4-6 hours once you have all the parts."

Maker Says

It's simple, easy to use, and looks great
Average Man

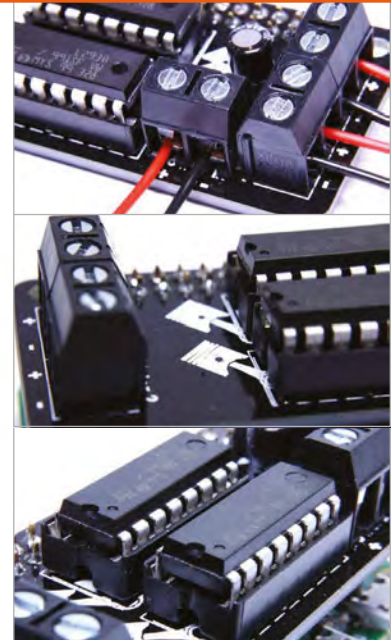
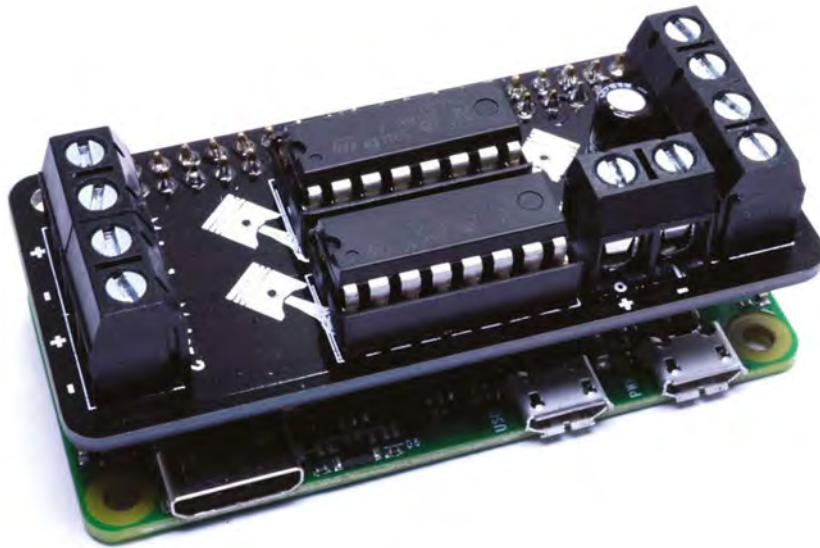

MOTOZERO

This Zero-size board lets you control up to four motors independently

Richard Saville, who blogs as the Average Man (magpi.cc/1Ypo4ez), came up with the design for the MotoZero while watching his favourite TV show, *Sons of Anarchy*. That biker influence has led to the coolest-looking motor board we've ever seen, resembling an exposed engine with its chunky terminals and twin socket-mounted driver chips. The attention to detail even extends to some piston graphics on the board. That's right, by the way: you get not one but two motor driver chips, enabling the MotoZero to control four motors independently. While the L293D chips used here have been around quite a long time, they do the job well enough, as they are fairly low-powered motors.

Design considerations

It's obvious that a lot of thought has gone into the MotoZero's design. The terminal blocks are high-quality and chunky, making it easy to connect your motor wires; their screw-heads are a decent size, too. These blocks should certainly stand up to prolonged use. The main terminal blocks are grouped in pairs, after sliding the ridge edges together, to avoid them being easily twisted out of place. Their positioning on either side of the Zero-sized board is ideal for powering the wheels on each corner of a robot. A fifth terminal block is supplied for the wires from your chosen power supply; alternatively, you could solder them directly to the board holes. One caveat to

mention here is that, due to its low cost, the MotoZero board lacks any protection from reverse polarity, so you need to make sure that your battery pack is connected the right way round!

Since the MotoZero is supplied in kit form, you'll need to assemble it, which involves a fair amount of soldering. While some people might be put off by this, Richard reckons it's all part of the fun of playing around with electronics. Depending on your soldering skills, it should take 30-60 minutes to put together; helpfully, the comprehensive PDF manual contains a step-by-step assembly guide illustrated with photos, while the board itself is clearly marked with component positions and labels. It's recommended to solder

Related

PICON ZERO

With numerous, configurable outputs and inputs, this fully featured Zero-size motor board is ideal for complex projects.



£13 / \$18

magpi.cc/1p9w6aA

magpi.cc/1XRfqGQ

£10 / \$14



MOTOR CONTROL PINS

The MotoZero allocates three GPIO pins to each of the four motor channels, as follows...

MOTOR 1:	MOTOR 2:	MOTOR 3:	MOTOR 4:
Enable pin – 5	Enable pin – 17	Enable pin – 12	Enable pin – 25
Positive – 24	Positive – 6	Positive – 23	Positive – 13
Negative – 27	Negative – 22	Negative – 16	Negative – 18

on the 40-pin GPIO header first, followed by the two chip sockets, then the four motor connection terminals, capacitor, and optional fifth terminal block. Just slot the two L293D chips into the sockets and you're good to go.

Twin drivers

Once the MotoZero is assembled, it's ready to control connected motors once slotted onto a Raspberry Pi. Incidentally, while the MotoZero's form factor is a perfect match for the Pi Zero, and Zero-sized robots, it can be used with any 40-pin Pi model.

As mentioned, the L293D driver chips are old technology, but still a good choice here since they are low-cost – thereby helping to keep the overall price down – and able to handle a wide range of voltages: from 4.5V to 36V. Handily, they also have built-in overheating protection and feature integrated flyback diodes to prevent damage from sudden voltage spikes from the motors. And even if they do get damaged, the socket mounting on the MotoZero makes them a cinch to replace.

One slight downside to using L293D chips is that they only supply 600mA continuous current per channel (i.e. motor). This means that you will need to use motors with a stall current not much higher than that: the manual states that you can get away with around 700mA, so long as you're careful to avoid stalling the motor and also keep an eye on chip temperature.

When it comes to controlling them, each motor channel is assigned three of the Pi's GPIO pins (which have been chosen carefully to avoid using any with special functions such as I²C, SPI, and UART). While the first two pins are turned HIGH/LOW or LOW/HIGH to make the motor turn forwards or backwards, as per usual, the third pin acts as a master on/off switch. While you might well wonder what the point of this 'enable' pin could be, one benefit is that it can be used with pulse-width modulation (PWM) to control the speed independently of direction.

Although the Python coding process will be similar to that for most other motor boards,

one major plus point is that the MotoZero is getting its very own output device class in the excellent GPIO Zero library (although at the time of writing, Ben Nuttall was still working on this), which should make it even easier for robotics novices to control motors with very few lines of code. Note, however, that if you want to attach any robot sensors – such as a line follower or ultrasonic distance sensor – you'll need to either wire them directly to pins by using a stacking GPIO header (instead of the one supplied), or stack a HAT underneath the MotoZero.

Last word

While it lacks some of the advanced functionality of more expensive motor boards, including servo control and GPIO inputs/through-holes for sensors, the MotoZero offers great value for money, looks very cool, and has the unusual ability to control four motors independently.



magpi.cc/1XrL6lv
£5 / \$7

Maker Says

Add motors to (almost) any Pi Zero project
4tronix

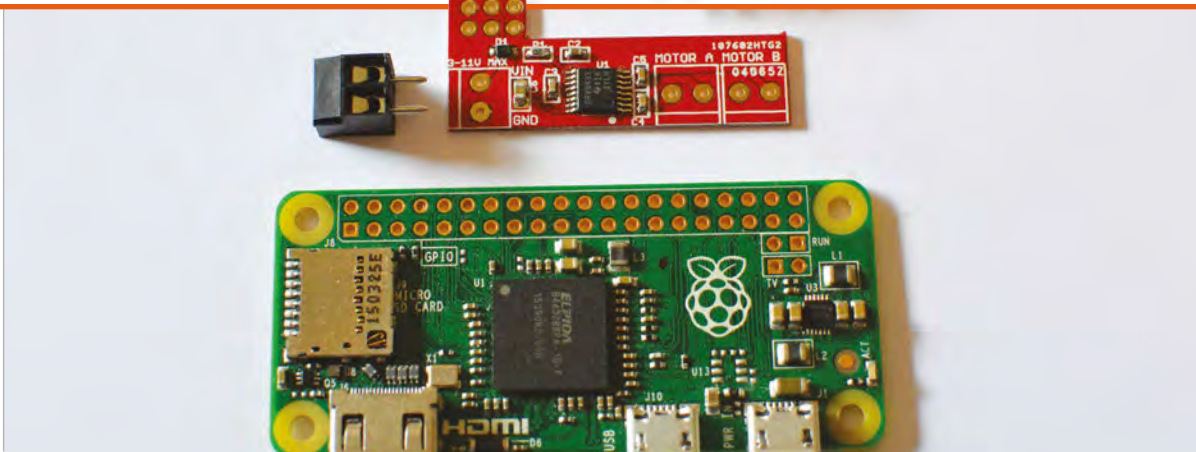

PZM – PI ZERO MOTOR SHIM

Not quite a motor board like the MotoZero, this little shim does let you control some motors with the Pi Zero

Related

PICOBORG

Another simple motor controller that can be used for robots or other motor tasks. It takes up more GPIO pins, though.



£7 / \$10

piborg.org/picoborg

We've seen some tiny add-ons for Raspberry Pis and even the Pi Zero in the past, but this motor shim from 4tronix has surprised us the most with its size. About as long as three micro SD cards laid end to end and not much wider (it's 38mm x 16mm), this tiny bit of PCB promises the ability to control two motors while taking up very little space in your project.

The shim comes as a kit you need to construct: the two motor terminals, a power terminal, and a couple of methods of attaching it to the GPIO ports. It does require a little bit of soldering, but even the most novice wielders of a soldering iron should have no problem with this and be done in about 20 minutes.

Due to how thin the board is (0.8mm, which is tiny), you can

easily mount it directly to the Pi Zero if you wish. It does come with some more straightforward methods, as mentioned above: a female header so you can attach it to a Pi Zero with a set of 40 GPIO pins attached, or a male header so it can just slot through the empty pins. It only needs six, as well, and uses the last six pins so that it doesn't take up the 5V and 3V3 pins at the front of the GPIOs. It's quite clever, although it does mean you need proper external power for it, like most motor boards.

The code for the board is quite simple, much like for the other 4tronix boards. Getting the Python module from their site lets you import it and give such commands as `pzm.forward` and `pzm.spinRight`, and also control

the speed. All very easy to use and implement into your project. We feel this particular shim goes beyond robot projects; after all, there are plenty of great dedicated robot-centred motor boards. Motors can do more than turn wheels, after all, although if you're making a particularly tiny robot, the shim should easily do for that as well.

Last word

It barely costs more than the Pi Zero, yet it lets you make tiny robots or add motors to any sort of Raspberry Pi project. The minimal assembly is great as well.



rasp.io/prohat

£15 / \$22

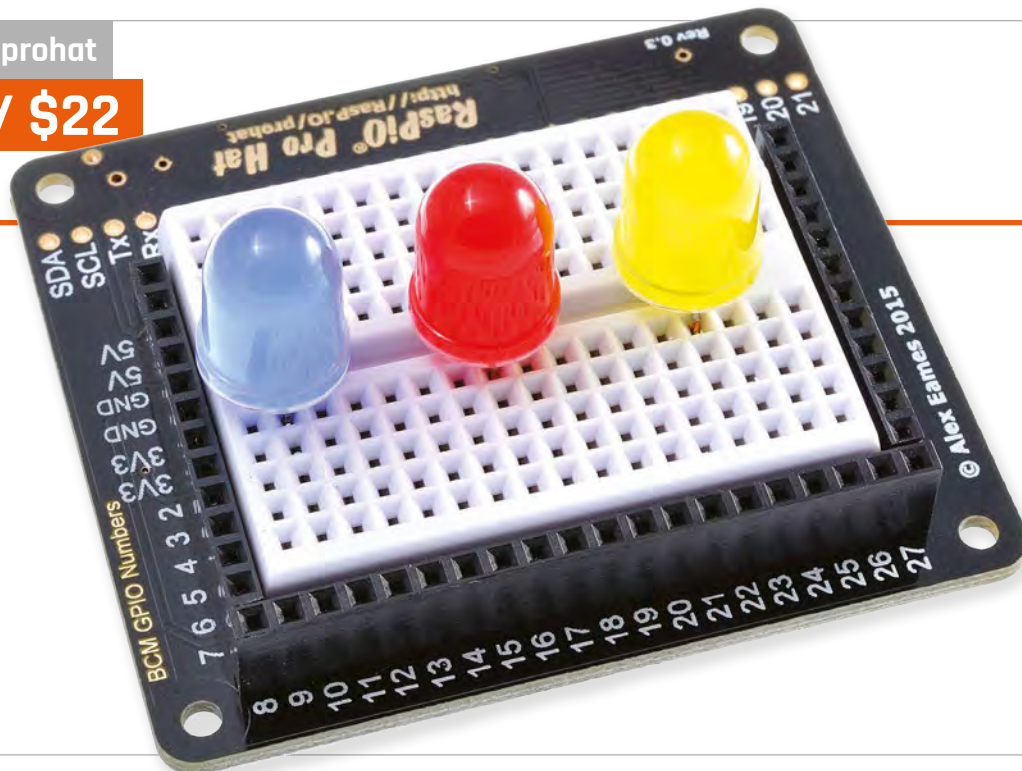

Maker Says

Putting your ports in perfect order and protecting them from human error
 RasPiO

RASPIO PRO HAT

Is this electronics prototyping HAT the easiest-to-use ever?

One obstacle that newcomers to Raspberry Pi physical computing come up against is trying to figure out which pin does what on the Pi's GPIO header, particularly since they're not labelled. Previous solutions have included printing out a GPIO pin reference guide on such items as rulers and key-rings. Alternatively, users could just refer to an online diagram, such as at pinout.xyz. Even then, you still need to count down the two lines of pins on the Pi to locate the one required, which increases the chance of a potentially damaging wiring mistake.

Enter the RasPiO Pro HAT. Designed by Alex Eames of raspi.tv, it makes using the GPIO pins a whole lot easier. Around the edges of its built-in breadboard are female header sockets connected to the Pi's GPIO pins, arranged and labelled in numerical (BCM) order. So, for instance, if you want to hook up a component to GPIO 18, you simply plug its jumper wire

into that labelled socket: no more pin-counting! Nor is any extra software required. The HAT works perfectly with GPIO Zero, as well as other libraries. It's such a simple solution, it's a wonder no one's thought of it before.

The third female header comprises six extra connections apiece for 3V3 and GND; this comes in handy, since the mini 72-point breadboard doesn't feature the '+' and '-' power rails of larger versions. In addition, you won't need quite so many jumper wires to power/ground all your components as they are, in effect, wired straight to the relevant GPIO pins. You may need to stock up on a few more male-to-male cables, though.

The other big advantage of the RasPiO is that it makes prototyping a lot safer, since a protection circuit with a 330Ω resistor and 3V3 Zener diode is built into each GPIO port. This means that you can use LEDs without extra resistors, and you won't damage your Pi's

GPIO by wiring something up incorrectly, although you still need to take care not to directly short 3V3 or 5V power to GND! One side effect of this protection circuitry is that some components requiring more than the 10mA limit, such as buzzers, may be underpowered; fortunately, a line of unprotected through-hole ports is included for this purpose.

Last word

The RasPiO Pro HAT really does make electronics easier, eliminating the need for counting GPIO pins while also protecting them against incorrect wiring. About the only drawback is a lack of room on its half-size breadboard, but if you do need extra space for components, you could easily hook it up to another breadboard.



Related

EXPLORER HAT PRO

While not as easy to use, it includes two H-bridge motor drivers, analogue inputs, built-in LEDs, touch pads, and capacitive clip pads.



£18 / \$23

magpi.cc/10AKy46

Maker Says

👉 A fully functional low-cost robot
Chickbot

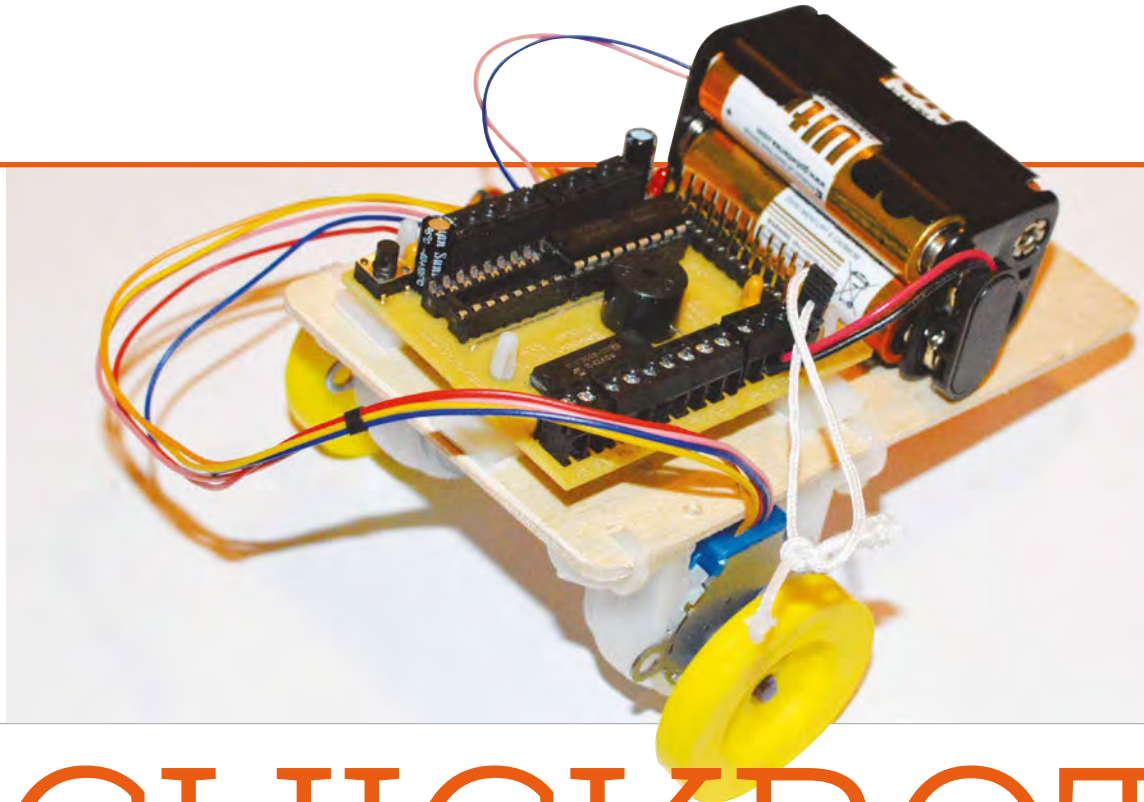

CHICKBOT RASPBERRY PI KIT

A very DIY robot that's designed to be fun to program and easy to assemble

It's been a little while since we've seen a full robot kit in the magazine, rather than just boards and controllers. The Chickbot is an educational robot kit aimed squarely at beginners, with a bigger focus on programming the robot than other aspects of it. Due to this programming focus, the actual physical chassis itself is very simple and bare-bones, requiring very little to actually build it from the supplied kit.

The build itself is very simple, with not even a screwdriver involved to put the chassis together until you start wiring in the motor cables. It's so low-tech, the tyres for the wheels are made from cut-up balloons, which are a bit of a nightmare to put on properly; this probably

does help to keep the cost down on the overall kit, though. We put it together in about an episode-and-a-half of *Pokémon*, so roughly half an hour, with the only really tricky bit being making sure all the right motor cables were going in the correct slot. It does come with some instructions, but a more thorough walkthrough guide is provided online that was of slightly more use to us.

Speed build

The build is a little flimsy and we're mildly concerned over how well the robot will fare with beginners playing around with it. It's not like it's going to completely shatter if you hit a wall at full speed (it's not particularly fast anyway), although if you find

yourself doing this, sticking a little foam tactically around the edge is pretty simple and quick.

A lot of the learning and building that's part of Chickbot is hosted on the website, and at the time of writing it's still under construction. A series of programming tutorials for the Raspberry Pi version are still being written, although it will guide you through a very basic program to get the LED and buzzer working in a preprogrammed manner. These tutorials are written in Python and use the RPi.GPIO library instead of GPIO Zero, and the robot needs to be programmed completely manually rather than using any supplied module or library. There's at least a well-commented Python script to get you going; however, it

Related

CAMJAM EDUKIT #3

Another cheap beginner's robot kit, it's supported in GPIO Zero, but doesn't come with a chassis.



£17 / \$25

magpi.cc/28KDW9S



“ We like how cheap it is and its focus on programming ”

can be a little tricky for a beginner to parse effectively and learn from.

Hopefully, when the tutorials are properly finished, you'll be able to truly exploit the educational and robotic powers of the Chickbot. The Arduino version is fully supported right now, with several tutorials on how to get the robot working, moving, and singing. The tutorials are useful and explain what they're doing in detail, so you'll definitely learn in the process. So far, this level of explanation is present in the available Raspberry Pi documentation, but it may be a little while before this full level of support is available on the website.

As for using it with a Raspberry Pi, really your best bet is a Model A+ or a Raspberry Pi Zero. The robot isn't very fast, so you could feasibly hold

a full-sized Pi as it trundles along, but a full-sized Pi rests awkwardly on top of the robot. The Zero and A+ fit a bit more snugly on top and don't significantly add to the weight of the chassis. While the tutorials suggest you hook it up to a monitor so you can program it manually in Python before running the script, we suggest prepping the Pi first to make sure you can SSH into it. That way you don't have to worry about cables running off the robot as you test it out, although for the lights and buzzer programs it's safe to hook it up.

Great potential

Overall, the Chickbot is an interesting kit. We like how cheap it is and its focus on programming; however, for the programming side it does need the documentation to

make it truly worthwhile. It must be said that it's still considered largely a beta product, so it will get this documentation; we've been told some more will be up by the time we go to press. If this sounds like a product you're interested in, then keep an eye out on the Chickbot website to figure out when the documentation is in a state that's ready for you.

Above There's a few components to assemble, but you can put them together pretty quickly with little hassle

Last word

A great little idea, but right now the Raspberry Pi version doesn't have quite enough documentation to make it as educational as it wants to be.



RASPBERRY PI BESTSELLERS GREEN TEA PRESS

Dr Downey's 'Think Like A ...' series is available as O'Reilly paperbacks, free Green Tea PDFs, or LaTeX source

THINK PYTHON, 2ND EDITION

Author: Allen Downey
Publisher: O'Reilly
Price: £29.99
ISBN: 978-1491939369
magpi.cc/28R52xq

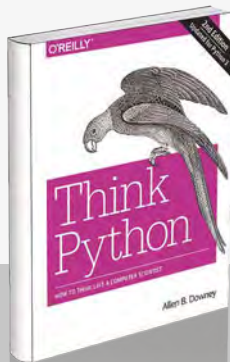

The highly regarded – and extremely popular – programming introduction, updated for Python 3. Readable and useful guide with nice examples, exercises, and good debugging information. Features in Coursera MOOC.

THINK BAYES

Authors: Allen Downey
Publisher: O'Reilly
Price: £19.99
ISBN: 978-1449370787
magpi.cc/28R57kw

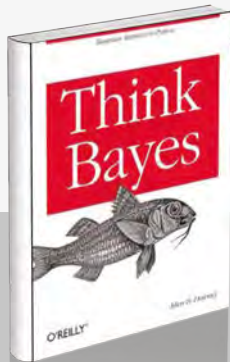

Teaches Bayesian analysis with Python code instead of calculus, making it easier to understand for programmers, and providing a path from simple to real-world examples.

THINK COMPLEXITY: COMPLEXITY SCIENCE AND COMPUTATIONAL MODELING

Authors: Allen Downey
Publisher: O'Reilly
Price: £26.50
ISBN: 978-1449314637
magpi.cc/28R56NH

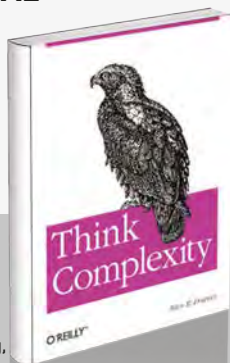

Downey covers complexity science, embracing "data structures and algorithms, intermediate programming in Python, computational modelling, and the philosophy of science" along the way! Concise, challenging, enjoyable.

PI 2 OWNERS' WORKSHOP MANUAL

Author: Gray Girling
Publisher: J H Haynes & Co
Price: £18.99
ISBN: 978-1785210730
magpi.cc/28R5mMs



Once upon a time, when cars had no computers, and were simple enough to maintain and repair by any competent home mechanic, Haynes manuals were first choice for how to work with any automobile. Now, while modern cars are too difficult to work on, but computers are heading back to the DIY ethos of the 1980s, Haynes' ongoing diversification efforts catches up with multicore Pis and the Zero. Not the Pi 3 though, but pity the poor publisher trying to keep up with Foundation developments.

The updated publication retains Haynes' clear layout and practical cookbook approach: this is a book to be dipped into and quickly

accessed for projects and answers, with the detailed contents sections squeezed into a double-page spread for instant access to all recipes. The ensuing introduction places the Pi squarely in the BBC Micro tradition, and ably and concisely introduces the philosophy of Free Software.

Recipes are grouped into software and hardware sections, leading onto projects ('Meal Plans') that are both useful (such as a media centre) and a platform for further learning; this includes a game of Snake as an immersive follow-up to the useful earlier Python introduction. A good Pi intro and ongoing reference.

Score



EXPERT PYTHON PROGRAMMING

Author: Michał Jaworski, Tarek Ziadé
Publisher: Packt
Price: £27.58
ISBN: 978-1785886850
magpi.cc/28R5KKQ



Adding a co-author to Packt's interesting but outdated guide to Python best practices for intermediate developers has resulted in a series of improvements to readability and code examples, and an update to Python 3 along with updates to tools to manage your code. The first chapter sums up the current status of Python use, ensuring you're comfortable with utilities such as pip and virtualenv, which nowadays are standard tools of Python coders.

Focusing strongly on "reliable code deployments and concurrency", and thus aimed at web developers and back-end engineers in particular, Jaworski

and Ziadé dive into best practices in syntax at various levels, from iterators, generators, and descriptors, to class-level improvements and metaprogramming. The authors then tackle good naming practices, and packaging and deploying code.

Documentation, test-driven development, and managing your code follow. Then locating bottlenecks, "the three rules of optimisation", and writing extensions in C, C++, Cython or Pyrex, along with the section on concurrency, will squeeze performance out of a language that optimises developer time over CPU time. Useful design patterns round off a book which will help many less experienced Python programmers step up to the next level.

Score



MAKE: ACTION:

Author: Simon Monk
Publisher: Maker Media
Price: £23.50
ISBN: 978-1457187797
magpi.cc/28R5VpP

This book is all about bringing action – music, light, and sound – to the Pi and the Arduino. Both boards are treated fairly equally, and it gives a good appraisal of which types of projects are best suited to one board or the other, although the low-cost Pi Zero changes the cost argument in the Pi's favour.

If you only have a Pi, there's plenty here to do and learn from: Monk's latest work is all about the dynamic possibilities of electronics. The projects are both interesting in themselves, and a good source of learning



and inspiration for developing your own Pi projects. If you're new to the Pi and electronics, introductory chapters cover Python and the GPIO library, then a practical look at electronics, moving from the general to the specific, and illustrated with hands-on experiments.

Several chapters cover different types of motors, giving motion to your project, and including 'Pepe, the Dancing Raspberry Pi Puppet', which returns in the sound chapter, gaining a voice. The IoT chapter sees Pepe connected to the internet and dancing each time his name is tweeted. Dr Monk's clear instructions and well-developed projects make an ideal introduction to electronics with your Raspberry Pi.

Score ★★★★★

THE ACCIDENTAL SYSADMIN HANDBOOK

Author: Eric A Kralicek
Publisher: Apress
Price: £27.99
ISBN: 978-1484218167
magpi.cc/28R6905

Accidental sysadmin is the term for anyone who has ended up with responsibility for an office's IT systems after unadvisedly revealing that they know how to change the printer toner or reboot the server, then finding it a short step to overall control of all the computers. There are many small organisations with no formally trained sysadmin, and your reviewer has trained many people in this position in a number of community organisations across the country.

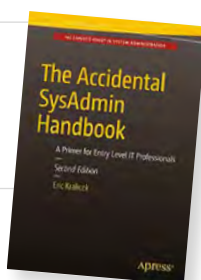

Many years ago, Ubuntu – installed on recycled hardware – was the most useful option, and today the Pi 3 is ideal as a surprisingly able small business server. A book needs to be written on this topic, but this is not that book: Kralicek instead gives a thorough grounding on sysadmin tasks, networking technologies, and various servers and services, but all from a rather MS-centric point of view.

Nevertheless, the higher-level overview presented in most chapters will be a useful introduction to essential areas for many people who have IT responsibility thrust upon them. In conjunction with a good Linux introduction, this handbook could help you put your organisation's IT in a saner and safer state, and save unnecessary problems.

Score ★★★★★

ESSENTIAL READING: COMMON LISP

Simple syntax, multi-paradigm, and frequently alleged to make you a better programmer...

Land of Lisp

Author: Conrad Barski
Publisher: No Starch
Price: £33.50
ISBN: 978-1593272814
landoflisp.com

The book of the website of the rock video (no, seriously), and the funnest introduction: learn Lisp "one game at a time".



Practical Common Lisp

Author: Peter Seibel
Publisher: Apress
Price: £47.49
ISBN: 978-1430242901
gigamonkeys.com/book

Comprehensive and well-written introduction that shows Lisp's power through a series of practical projects.



Paradigms of Artificial Intelligence Programming

Author: Morgan Kaufmann
Publisher: Morgan Kaufmann
Price: £43.99
ISBN: 978-1558601918
norvig.com/paip.html

This 25-year-old book goes far beyond AI, and teaches more about programming than you'd believe!



Let Over Lambda

Author: Doug Hoyte
Publisher: Lulu
Price: £30.50
ISBN: 978-1435712751
letoverlambda.com

Opinionated but essential guide to advanced Lisp use, focussing on macros – programs that write programs – and how to break rules.

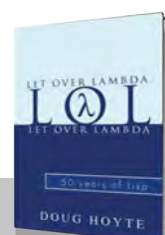

Common Lisp Recipes

Author: Edmund Weitz
Publisher: Apress
Price: £41.50
ISBN: 978-1484211779
magpi.cc/28R6xM9

Lisp veteran Weitz takes a practical engineer's approach to the language, producing the best intermediate-level general Lisp reference.



THE MONTH IN RASPBERRY PI

Everything else that happened this month in the world of Raspberry Pi

While he won't be Sir Eben when he receives the honour, Lord Commander seems to be catching on in the Raspberry Pi office



EBEN UPTON PUT ON HONOURS LIST

Explaining the whole knighthood and honours system in the UK can be a little tricky.

Basically, to celebrate the Queen's birthday, a selection of British citizens are chosen to be honoured for their contributions to British society in some way. Usually you hear of those that have knighthoods for their work in cinema (Sir Patrick Stewart, Dame Judi Dench, etc), or in fields such as

Right Tim's contributions to science won't be ending with his return, so there's always time for him to get knighted in the future



ORDERS OF THE BRITISH EMPIRE

A full list of the honours you can receive in the UK in ranking order

KNIGHT GRAND CROSS or DAME GRAND CROSS

of the Most Excellent Order of the British Empire
Abbreviated: GBE | Title: Sir/Dame

KNIGHT COMMANDER or DAME COMMANDER

of the Most Excellent Order of the British Empire
Abbreviated: KBE or DBE | Title: Sir/Dame

COMMANDER

of the Most Excellent Order of the British Empire
Abbreviated: CBE | Title: None

OFFICER

of the Most Excellent Order of the British Empire
Abbreviated: OBE | Title: None

MEMBER

of the Most Excellent Order of the British Empire
Abbreviated: MBE | Title: None

business and science. There are several ranks to them, but they all mean that the Queen has noticed you for outstanding achievements.

Eben Upton, co-creator of the Raspberry Pi and current CEO of Raspberry Pi Trading, has been given one of these birthday honours. To be exact, a CBE, or Commander of the Most Excellent Order of the British Empire. The honour is being bestowed upon Eben for his 'services to Business and Education'.

Space honour

While we're still in our Astro Pi special issue, we'd be remiss not to mention that Tim Peake also received an honour. Apparently he's the first person to ever be honoured while in space. As his work did not take place in the United Kingdom (although let's not argue about who 'owns' space), Tim received the Companion of the Order of St Michael and St George, or CMG, for his contributions to space research and scientific education. Having seen the way kids react to him and the way they've embraced STEM this year, we'd definitely say he's earned it.

CROWDFUND THIS!

The best crowdfunding hits this month for you to check out...



DARK CONTROL: ROBOT CONTROLLERS

kck.st/1S3yHfv

Earlier in this issue we covered the MotoZero, which allows you to control four motors from a Pi Zero-sized board. The Dark Control wants to let you control six motors from your Pi Zero. It comes in two flavours: a board that powers six DC motors, and another that controls six ESC (electronic speed control) powered motors. Six independent motors is a lot – most Pi robot boards do two or four, so six opens up a few more options. This could mean more wheels or just motors that control other aspects of a robot. You could even build a hexcopter with enough patience.



MYPI: INDUSTRIAL STRENGTH IOT

kck.st/1thu6Cm

This is an interesting project: a Raspberry Pi Compute Module board that completely opens it up to just about every function you might need in a more serious internet-connected device. It has a 3G modem, Ethernet port, bulk storage, serial ports for RS232 and RS485, 'easily expandable IO', a DC power supply input, and industrial-style design considerations. It looks fairly ridiculous and all this ridiculousness will set you back about £99 when its launched, minus Compute Module, so if you're interested you can probably get a bargain on its Kickstarter.

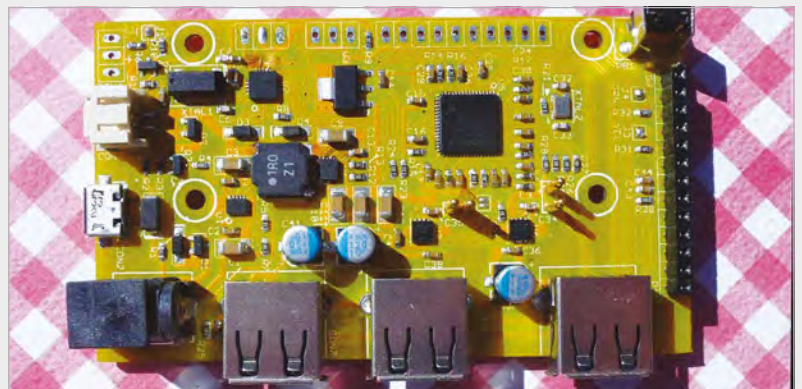

SOLAR PI PLATTER

magpi.cc/28NugPO

"Look at the Pi Zero. It's small, really cheap, and sips power. Seems like it's made to wander around," reads the pitch on this solar power station board for the Pi Zero. It fits under the Pi Zero, so it leaves the GPIO pins clear and it comes with several more functions as well, such as three extra USB ports, a real-time clock, and a couple sets of motor control pins. It's just been launched at the time of writing, so give it a look and see if it's something for you.

BEST OF THE REST

Here are some other great things we saw this month

GAME BOY COLOR NANO

magpi.cc/28MJr7P



People keep fitting Pi Zeros into ever smaller cases, this time an old Burger King Game Boy toy. It's fully functional and made waves on /r/gaming (Reddit), where they predictably complained it was showing a GBA game. Most people loved it, though.

magpi.cc/28Mv3Zm



RASPBERRY PI HAL9000

This is a voice-controlled replica of the famous computer system from *2001: A Space Odyssey*. It costs around \$100 to build and this version looks lovely thanks to a great attention to detail. You can probably make sure it does open the pod-bay doors as well.

6 CNM SUMMER CAMP

Albuquerque, NM, USA

RASPBERRY JAM EVENT CALENDAR

Find out what community-organised, Raspberry Pi-themed events are happening near you...

PUT YOUR EVENT ON THE MAP

Want to add your get-together? List it here:
raspberrypi.org/jam/add

1

RASPBERRY JAM LEEDS

When: Wednesday 6 July

Where: Swallow Hill Community College, Leeds, UK

magpi.cc/28K6EDD

An event aiming to bring people together from across a wide area to discover the exciting potential of the Raspberry Pi computer.

3

STAFFORD RASPBERRY JAM

When: Wednesday 13 July

Where: King Edward VI High School, Stafford, UK

magpi.cc/28K6NqI

A big meetup where Pi enthusiasts get together, share ideas, help each other, and most of all have fun!

5

COVENTRY AND WARWICKSHIRE RASPBERRY JAM #3

When: Wednesday 20 July

Where: Nicholas Chamberlaine School, Bedworth, UK

magpi.cc/28KJBNj

A meetup for people who have a Raspberry Pi or want to learn more about the Raspberry Pi.

2

TORBAY TECH JAM

When: Saturday 9 July

Where: Paignton Library & Information Centre, Paignton, UK

torbaytechjam.org.uk

A fun, family-friendly event to inspire young people to take an interest in computing and STEM.

4

SLICE OF PI CLUB

When: Tuesday 19 July

Where: Heart of Worcestershire College, Redditch, UK

magpi.cc/28KJfpE

The Slice of Pi Club is set up to bring like-minded people together to learn about the wonderful world of the Raspberry Pi computer.

6

CNM SUMMER CAMP

When: Friday 22 July

Where: Central New Mexico Community College, Albuquerque, NM, USA

magpi.cc/28KJZeN

Explore all the great things you can do with a Raspberry Pi. Let's have a fun day of learning and exploring!

2 TORBAY TECH JAM

Paignton, UK

8 RASPBERRY JAM PRESTON

Preston, UK

1 RASPBERRY JAM LEEDS

Leeds, UK

3 STAFFORD RASPBERRY JAM

Stafford, UK

5 COVENTRY AND WARWICKSHIRE RASPBERRY JAM #3

Bedworth, UK

7 TRURO RASPBERRY JAM

Truro, UK

4 RASPBERRY JAM: SLICE OF PI CLUB

Redditch, UK

TRURO RASPBERRY JAM**When:** Saturday 23 July**Where:** Truro College,
Truro, UKmagpi.cc/28KKiWS

The first ever Truro Raspberry Jam to bring together enthusiastic and beginner Raspberry Pi users in the county of Cornwall.

7

RASPBERRY JAM PRESTON**When:** Monday 1 August**Where:** Media Factory Building,
Preston, UKmagpi.cc/28KKNAa

Join the Preston Pi community as they learn, create, and share the potential of the Raspberry Pi computer at an open, family-friendly event.

8

DON'T MISS: CNM SUMMER CAMP**When:** Friday 22 July**Where:** Central New Mexico
Community College,
Albuquerque, NM, USA

The CNM Summer Camp is a course held during summer break for middle and high school students, so they can learn in a college-style environment. Of the many courses on offer, you can spend a full day at their own Raspberry Jam, learning about how the Raspberry Pi works and seeing demos of it. For more details, check out the event page: magpi.cc/28KJZeN

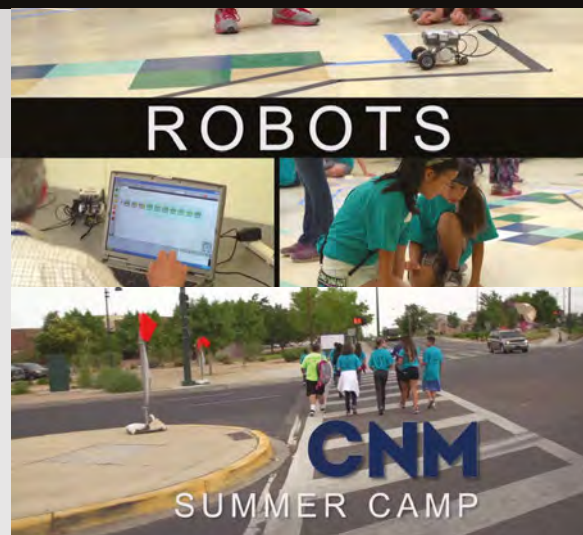

YOUR LETTERS



All the merch

I saw a tweet on the Raspberry Pi account where someone was wearing a Raspberry Pi T-shirt and a *MagPi* hat, while drinking from a Raspberry Pi mug. I knew there was Raspberry Pi merchandise, but I didn't know there was *MagPi* merchandise. Can I get both of them from the same store, or are they in different stores online?

Thanks,
Lisa Allyn

That was actually our Features Editor, Rob Zwetsloot. The T-shirt is available from the Raspberry Pi Swag shop (swag.raspberrypi.org) along with other shirts and merch. That specific cup isn't for sale yet, but probably will be soon (if it's not already when this mag goes on sale); there's also another type of mug you can buy on the store. As for the hat, unfortunately it's a one of a kind that was custom-made. We don't currently have any other merchandise, unfortunately; we have been thinking about making some, however, so watch this space.

For the cosplayers

I really liked the tutorial on doing Sans' LED light-up eye in the magazine [issue 45]. I've been trying to think of a way to do cosplay electronics for a while now and it was great to see some inspiration from one of my favourite magazines. Will you do more tutorials on how to incorporate the Raspberry Pi into costumes or clothing in general? I've got some ideas for costumes (and Christmas jumpers!) that I'd like to use them for.

Yu Kimura

It was a lot of fun to make, even if there was some emergency soldering that had to be done at the convention. Finishing costumes at the hotel is fairly normal for cosplayers, though. We've been thinking about doing more to do with costuming and wearables here at *The MagPi*; our Features Ed and resident cosplayer has been planning a big build that we'll probably cover in here if he ever does it. So hopefully, we can do more cosplay electronics tutorials. Actuators, buttons, sounds, displays, and a mic maybe? We'll see what we can do.

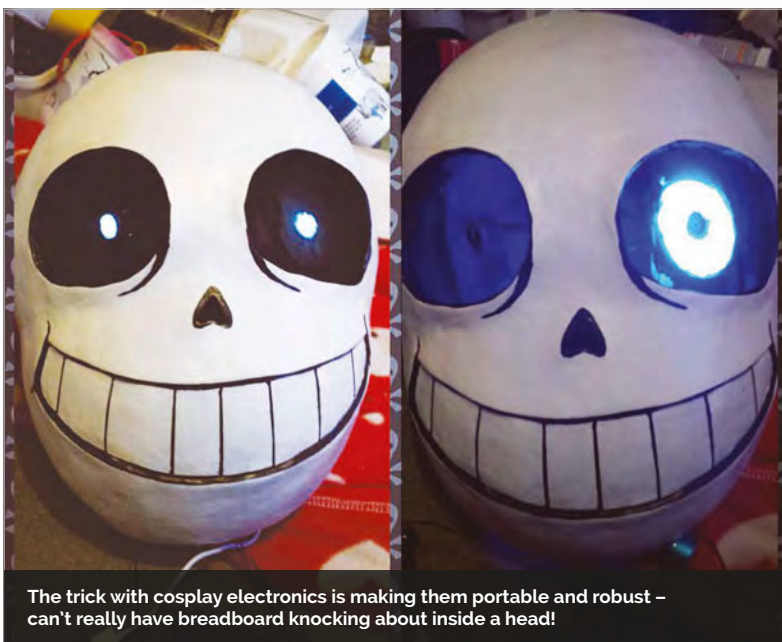

The trick with cosplay electronics is making them portable and robust – can't really have breadboard knocking about inside a head!



Python version

In the last issue of the magazine, I noticed you'd been doing a lot more Python 3 code. I'm a big proponent of doing tutorials in Python 3 over Python 2, so I was happy to see this. Was this intentional at all? I've noticed in the past you've done a mixture of Python 2 and Python 3 tutorials. **Mark N**

Yep, we've been trying to make sure all our code is Python 3 where possible since last issue. It means a lot of our tutorials are a bit more future-proof, as Python 2 is very slowly phased out over the next couple of years. The Raspberry Pi Foundation also likes to do a lot of its resources in Python 3 as well, so it just makes sense to do so. There's really not all that much new to learn from the switch, but we'll probably do a conversion article in a future issue!

Adventure's end

I've really been enjoying following along with Astro Pi and Tim Peake's adventures over the last several months of the magazine but as I write this, Tim's mission is coming to an end. I'm looking forward to seeing some of the experiment results, and my kids are excited to see his landing, but I'm now wondering if we'll ever see as many space articles in *The MagPi* as when he was in space. Are there any plans to carry on your astronomical coverage?

Regards,
Keith C

If you've read this far into the magazine, you've probably noticed that we've had a huge, massive Astro Pi feature to celebrate Tim's return. As part of that article, we discussed the future of Astro Pi and how there were already plans to use it when French astronaut Thomas Pesquet makes his way up to the ISS at the end of the year. There are also plans for Astro Pi kits to be spread around the ESA countries, so hopefully there'll be experiments and competitions from them. We'll definitely cover as much as we can regarding that. We've also got another round of Skycademy coming up, if you like reading up on the Pi as a HAB computer, and we'll be covering that as well. There's still plenty of room for space content in the mag!

FROM THE FORUM: SPRITE SENSE

The Raspberry Pi Forum is a hotbed of conversations and problem-solving for the community – join in via raspberrypi.org/forums

In the November 2015 issue of *The MagPi* (issue 39), how do I get the sprites in the article 'Pixel art on Sense HAT'?

The link takes me to a page that is one file with all the sprites. How do I pick out just one to test the program?

pixster

The file in question is a sprite sheet, created by someone not related to Raspberry Pi, that just holds a hundred 8×8 famous character sprites. For this tutorial, you'll need to cut out the sprite you wish to use (in fact, there's a step in the tutorial all about how to do this). Alternatively, you can find the code this tutorial was based on to display every single character from the sprite sheet here: magpi.cc/28KXAT4. There's less cutting out this way!

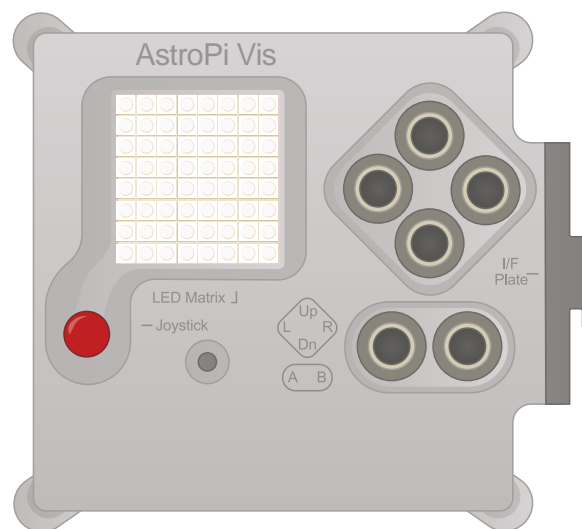

Above This is definitely not the last we'll see of the Astro Pi in the pages of this magazine

WRITE TO US

Have you got something you'd like to say?

Get in touch via magpi@raspberrypi.org or on The MagPi section of the forum at raspberrypi.org/forums

READ US ANYWHERE



SAVE 25%
with a Newsstand subscription
(limited time offer)

DO SCIENCE WITH THE SENSE HAT

WITH OUR NEW **ESSENTIALS E-BOOK**

AVAILABLE ON THE MAGPI APP!

ONLY £2.99 \$3.99



FREE: DOWNLOAD ALL 30 ORIGINAL ISSUES

The MagPi Magazine

Available now for smartphones & tablets



Subscribe from
£2.29 or £26.99
rolling subscription full year subscription

Download it today - it's free!

- Get all 30 legacy issues free
- Instant downloads every month
- Fast rendering performance
- Live links & interactivity

In association with

IQaudio

WWW.IQAUDIO.CO.UK

10 Pi-DAC+

with Pi-CASE+ smoked cases

MUST BE WON!

WHAT NOUN IS COMMONLY USED TO DESCRIBE HI-FI ENTHUSIASTS?

The IQ Audio Pi-DAC+
delivers outstanding sonic
performance and full HD audio

Also available at: pi-shack.com

**Tell us by 25 July
for your chance to win!**

Simply email competition@raspberrypi.org
with your name, address and answer!

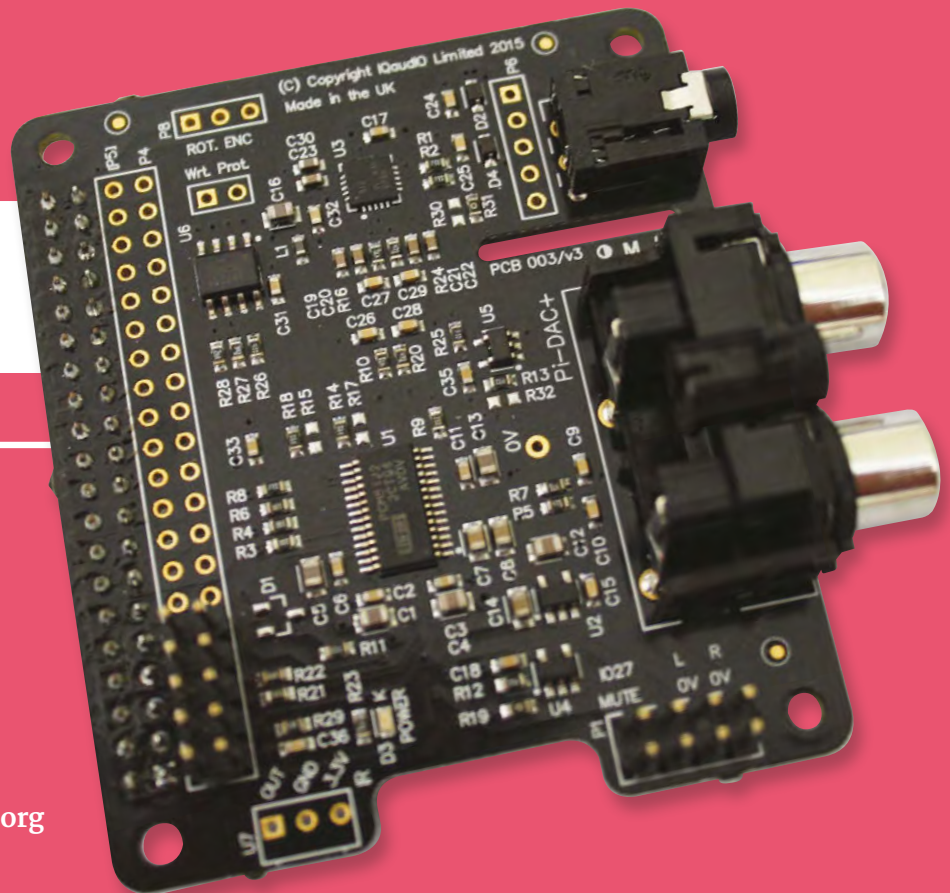

Terms & Conditions

Competition closes 25 July 2016. Prize is offered worldwide to participants aged 18 or over, except employees of the Raspberry Pi Foundation, the prize supplier, their families or friends. Winners will be notified by email after the draw date. By entering the competition, the winner consents to any publicity generated from the competition, in print and online. Participants agree to receive occasional newsletters from The MagPi magazine (unless otherwise stated upon entry). We don't like spam. Participants' details will remain strictly confidential and won't be shared with third parties. Prizes are non-negotiable and no cash alternative will be offered.

MATT RICHARDSON

Matt is Raspberry Pi's US-based product evangelist. Before that, he was co-author of *Getting Started with Raspberry Pi* and a contributing editor at *Make* magazine.



SUCCESSFUL ACCESSORIES

From HATs to cases, **Matt Richardson** explores the Raspberry Pi product ecosystem

The success of Raspberry Pi as a computer has created a large market for accessories. That market strengthens Raspberry Pi's value, which makes for a wonderful positive feedback loop that amplifies and enhances the world of Raspberry Pi for everyone. I've been thinking a lot about the Raspberry Pi ecosystem and how to find success in it. While there are many ways to be a part of this ecosystem, such as creating content or selling kits, I especially like the market for accessories.

HATs are a particular favourite of mine. If you're not familiar them, HAT stands for Hardware Attached on Top. It's the specification for Raspberry Pi add-on boards which can be placed on the GPIO pins. A Raspberry Pi HAT is often a basic extension of the capabilities of the product. It can add functionality like motor control, analogue input, or motion sensors. It can be used to interface the Raspberry Pi with other technologies like a wireless transceiver, e-ink display, or high-end audio devices. HATs make it easy for you to use other hardware with Raspberry Pi without the need to create a mess of jumper wires, components, and data sheets.

Not all HATS are one-trick ponies. Some do a bunch of different things. For example, Pimoroni's Explorer HAT Pro has capacitive touch pads, RGB LEDs, analogue input, motor drivers, and a convenient breadboard on top. And our own Sense HAT has an 8x8 RGB LED matrix, joystick input, and sensors for motion, orientation, acceleration, temperature, pressure, and humidity. With these multipurpose HATs, you can explore a lot of different project ideas without a lot of fuss.

I also like HATS that make Raspberry Pi more useful to other communities of enthusiasts. Those of you who are interested in building your own

flying drone might like Navio 2, which adds a lot of the necessary functionality to make your own autonomous drone with Raspberry Pi at its core. With Navio 2, drone-building hobbyists can leverage the power of Raspberry Pi and its community for their own projects.

Useful and stylish

Beyond HATs, there are many other kinds of useful accessories, such as cases, adapters, and mounts for Raspberry Pi. Just a few days ago, I came across a new product called ZeroView by The Pi Hut. It's a suction-cup mount for a Raspberry Pi Zero or Model A+ and a Camera Module. It lets you easily point the Raspberry Pi Camera Module out of a window so that you can set up your own time-lapse rig, security camera, or dashcam. I suspect that this product will be very successful since a lot of people use Raspberry Pi in these sorts of applications.

While some accessories like ZeroView are very clever and useful, others are fun and stylish. I'd recommend that you check out Raspberry Pi cases created by C4Labs. They've mastered the use of wood and acrylic to make some unique enclosures. Some are inspired by hot-rod cars, while others look more natural and organic. Of course, if you're being practical, a case can be a very simple object, but it's also a chance for a Raspberry Pi owner to add splash of style and fun to it.

As Raspberry Pi enthusiasts, we're lucky to have such an amazing group of entrepreneurs making useful, interesting, and creative products to go along with the world's most famous affordable computer. With the strong growth of the platform, there's an opportunity for more innovation and creativity in this space and I can't wait to see what happens next!

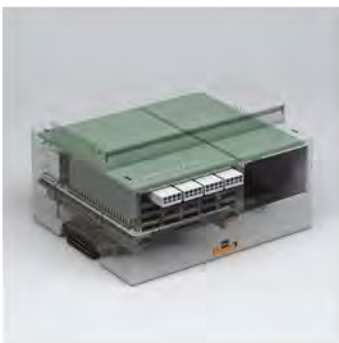
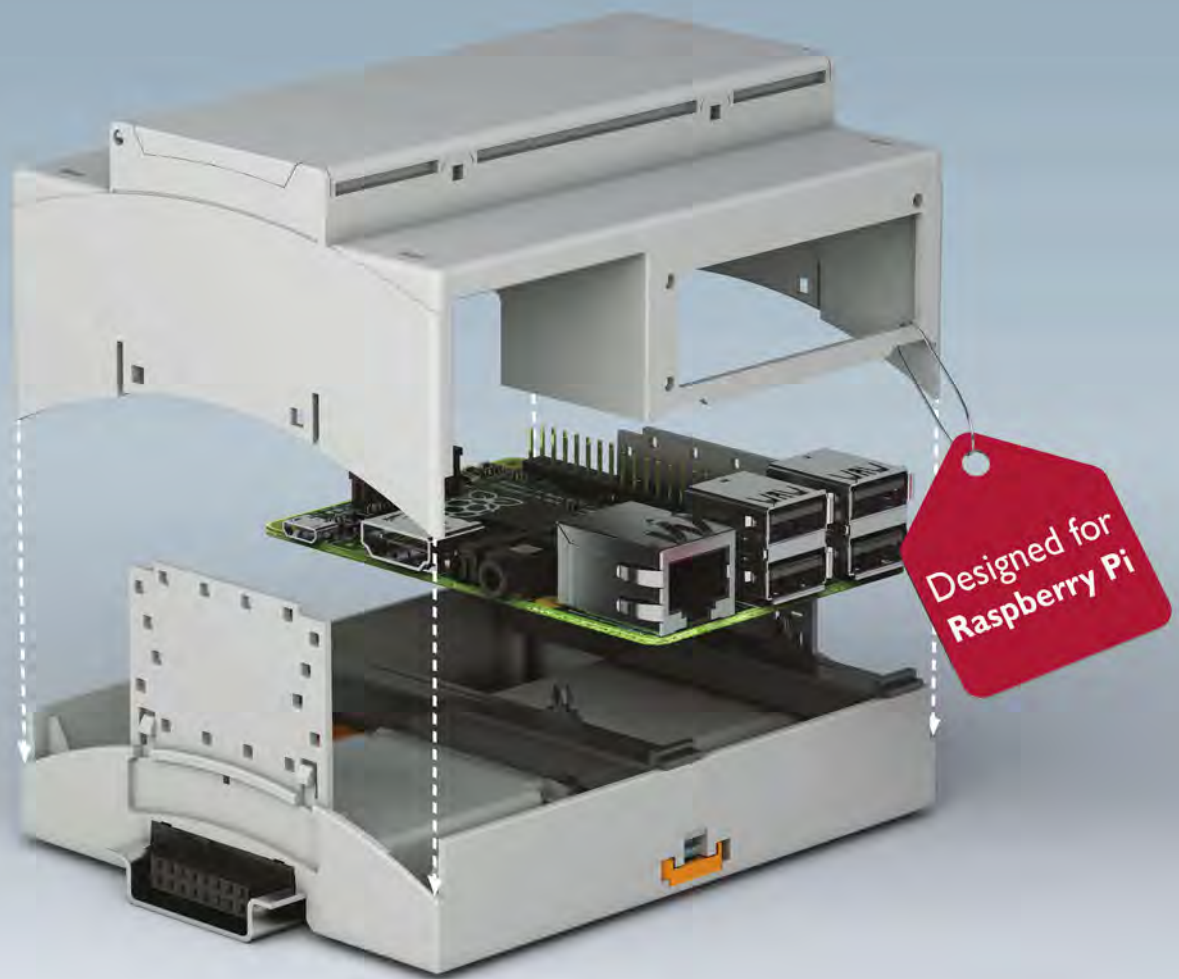

Raspberry Pi gets a new home

Industrial automation with Raspberry Pi just got easier

The new RPI-BC enclosure is designed specifically to accommodate Raspberry Pi computers. The DIN rail or wall mountable enclosure provides access to all ports, GPIO pins and SD card without removing the lid. Ideal for all industrial automation projects.

For additional information call 0845 881 2222 or visit phoenixcontact.co.uk

LEARN TO CODE WITH SCRATCH

Get started today for
just £2.99 / \$3.99

MAKE GAMES AND APPLICATIONS
WITH YOUR *Raspberry Pi*

The
MagPi
ESSENTIALS

From the makers of the
official Raspberry Pi magazine



Available on the
App Store



GET IT ON
Google Play

Find it on
The
MagPi
digital app

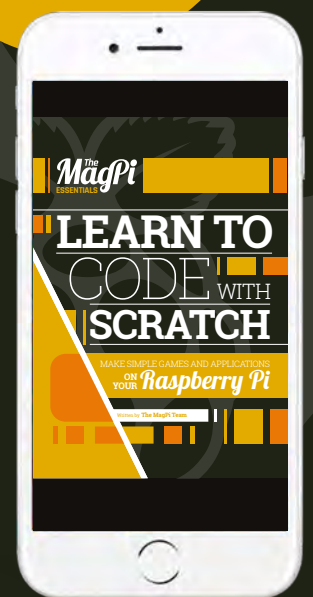

magpi.cc/Scratch-book

Expand your Pi

Stackable expansion boards for the Raspberry Pi

Serial Pi Plus

RS232 serial communication board. Control your Raspberry Pi over RS232 or connect to external serial accessories.

Breakout Pi Plus

The Breakout Pi Plus is a useful and versatile prototyping expansion board for the Raspberry Pi

ADC Differential Pi

8 channel 18 bit analogue to digital converter. I²C address selection allows you to add up to 32 analogue inputs to your Raspberry Pi.

IO Pi Plus

32 digital 5V inputs or outputs. I²C address selection allows you to stack up to 4 IO Pi Plus boards on your Raspberry Pi giving you 128 digital inputs or outputs.

RTC Pi Plus

Real-time clock with battery backup and 5V I²C level converter for adding external 5V I²C devices to your Raspberry Pi.

1 Wire Pi Plus

1-Wire[®] to I²C host interface with ESD protection diode and I²C address selection.

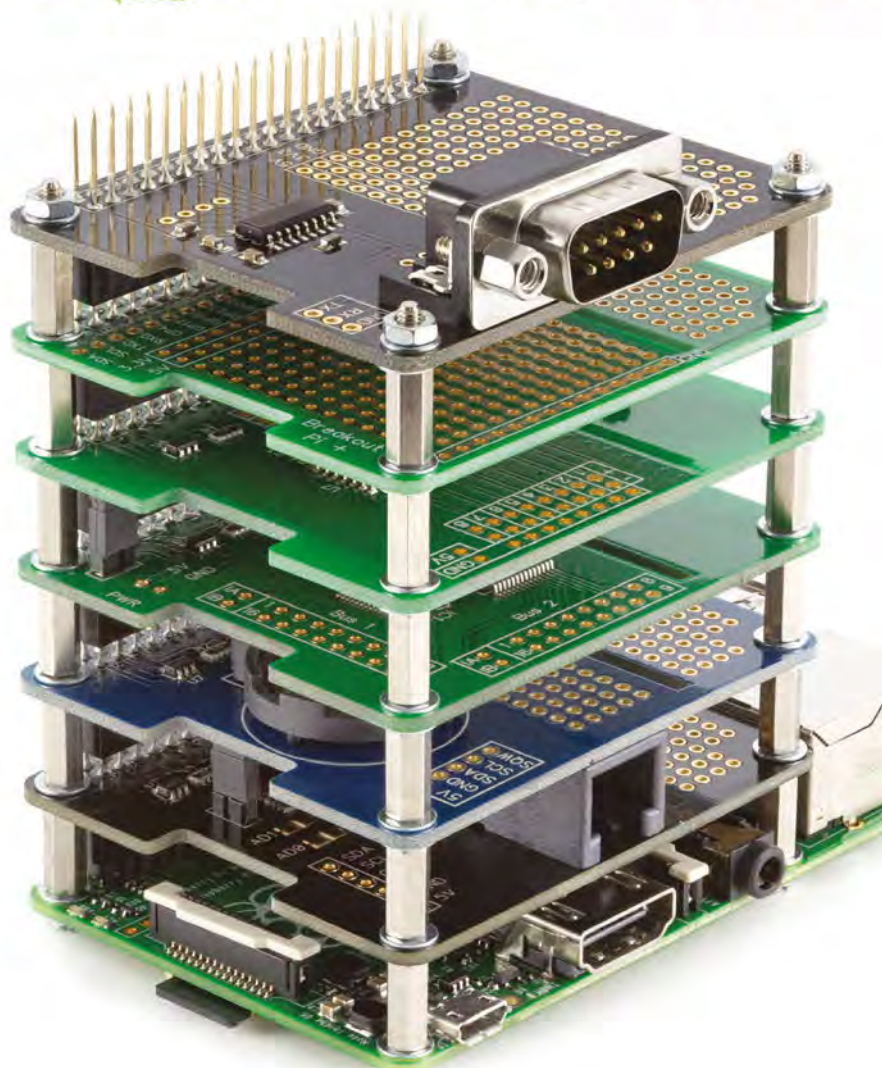

Now Available for the Pi Zero



ABelectronics UK

www.abelectronics.co.uk



DEXTER

INDUSTRIES

SAVE
15%
"MagPi15"
discount code



BrickPi

Build a LEGO robot with your Raspberry Pi!

GoPiGo

Everything you need to build a Raspberry Pi robot!



GrovePi

Connect hundreds of sensors to your Raspberry Pi!